

BORING TOOLS

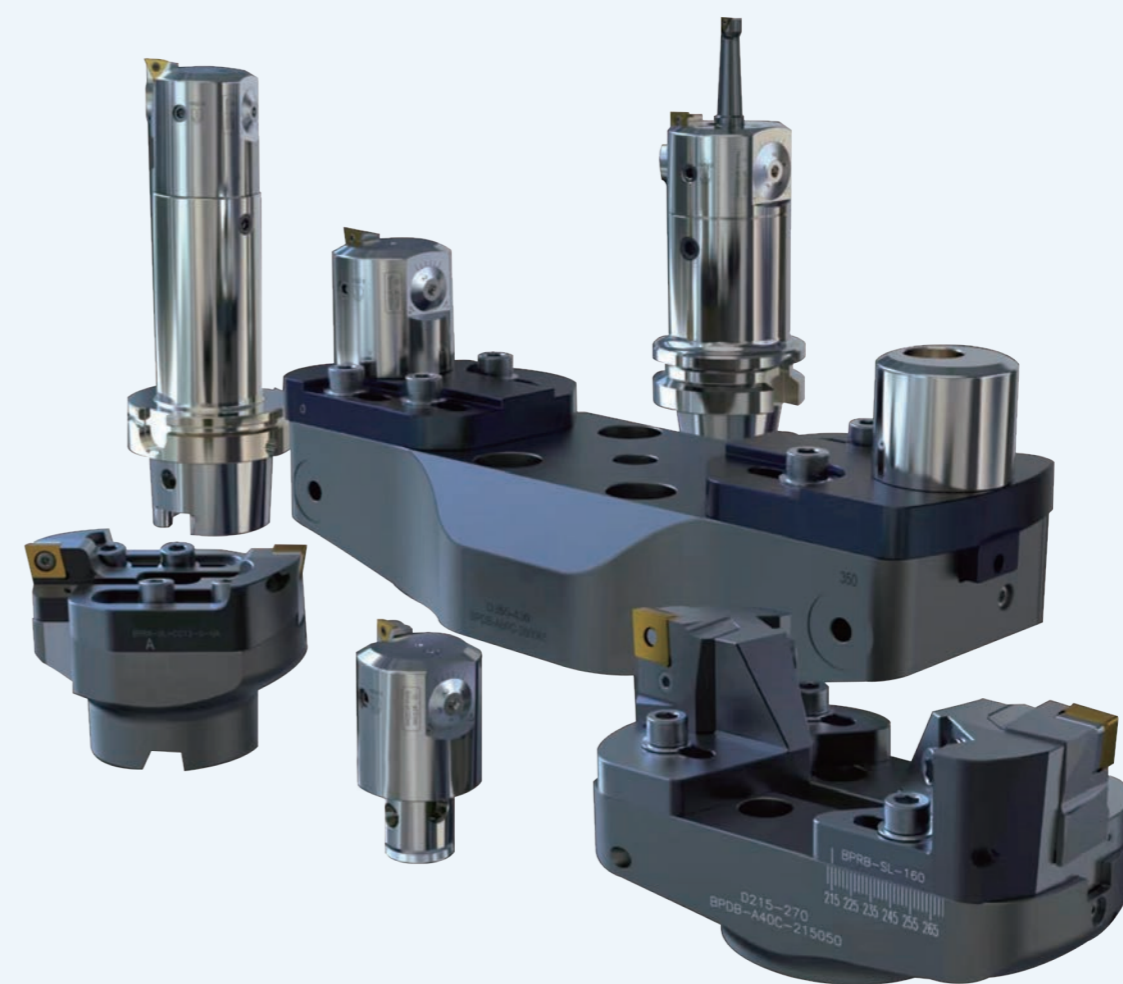

镗刀

BORING TOOLS

C 镗刀 - 目录

BORING TOOLS CONTENTS

设计特点 Design Features — C06

命名方式 Naming And Coding Rules — C08

粗镗刀BRA系列 BRA Series — C09

BRA-CC系列	BRA-CC Series	C10
BRA-CC系列滑块式刀夹	BRA-CC Series Sliding Cartridge	C11
BRA-TC系列	BRA-TC Series	C13
BRA-TC系列滑块式刀夹	BRA-TC Series Sliding Cartridge	C14
BRA-SC系列	BRA-SC Series	C16
BRA-SC系列滑块式刀夹	BRA-SC Series Sliding Cartridge	C17
BRA系列刀座	BRA Series Adaptor	C19

粗镗刀BRB系列 BRB Series — C20

BRB-CC-S系列	BRB-CC-S Serie	C21
BRB-CC-S系列刀夹	BRB-CC-S Series Cartridge	C23
BRB-TC-S系列	BRB-TC-S Series	C24
BRB-TC-S系列刀夹	BRB-TC-S Series Cartridge	C26
BRB-SC-S系列	BRB-SC-S Series	C27
BRB-SC-S系列刀夹	BRB-SC-S Series Cartridge	C29
BRB-CN-D系列	BRB-CN-D Series	C30
BRB-CN-D系列刀夹	BRB-CN-D Series Cartridge	C33
BRB-SN-D系列	BRB-SN-D Series	C34
BRB-SN-D系列刀夹	BRB-SN-D Series Cartridge	C36
BRB-CN-P系列	BRB-CN-P Series	C37
BRB-CN-P系列刀夹	BRB-CN-P Series Cartridge	C40
BRB-SN-P系列	BRB-SN-P Series	C41
BRB-SN-P系列刀夹	BRB-SN-P Series Cartridge	C43
BRB系列桥架式刀座	BRB Series Brigde Adaptor	C44
BRB系列滑块	BRB Series Slide	C46

精镗刀BFA系列 BFA Series — C47

BFA-TC系列	BFA-TC Series	C48
BFA-TC系列刀座	BFA-TC Series Adaptor	C52
BFA-TC系列刀夹	BFA-TC Series Cartridge	C53
BFB-TC系列配重滑块	BFA-TC Series Extended Washer Assembly	C54

精镗刀BFB系列 BFB Series — C55

BFB-TC系列	BFB-TC Series	C56
BFB-TC系列滑块	BFB-TC Series Slide	C58
BFB-TC系列配重滑块	BFB-TC Series Slide(CW)	C59
BFB-TC系列精镗刀座	BFB-TC Series Adaptor	C60
BFB-TC系列配重块	BFB-TC Series Counter-Weight	C61



C 镗刀 - 目录

BORING TOOLS CONTENTS

精镗刀BFC系列 BFC Series — C62

BFC-TC系列	BFC-TC Series	C63
BFC-TC系列精镗刀座	BFC-TC Series Adaptor	C64
BFC-TC系列刀夹	BFC-TC Series Cartridge	C65

接口简图 Coupling Diagram — C66

芯轴接口	Arbor	C66
CKB接口	CK	C66

BFC系列镗杆 Boring Bar BFC Series — C67

命名方式	Naming And Coding Rules	C68
BFC-TC系列镗杆	Boring Bar BFC-TC Series	C69

镗刀转接柄 Boring Tool Adaptor Holder — C70

命名方式	Naming And Coding Rules	C71
CK基础柄 HSK系列	CK Connection With HSK Adaptor	C72
CK基础柄 BT系列	CK Connection With BT Adaptor	C74
CK基础柄 SK系列	CK Connection With SK Adaptor	C76
CK接口等径延长杆	Extension With CK Adaptor	C78
CK接口缩径杆	Reduction With CK Adaptor	C79
芯轴基础柄 BT系列	Arbor Connection With BT Adaptor	C81
芯轴基础柄 SK系列	Arbor Connection With SK Adaptor	C83
芯轴基础柄 HSK系列	Arbor Connection With HSK Adaptor	C85
转接柄	Transfer Adaptor	C86
刀具扩展组装示意图	Extended Tools Assembly View	C87

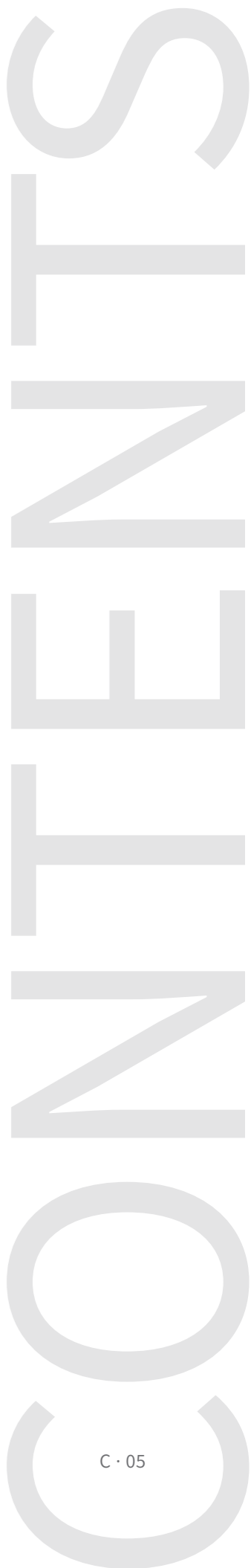

设计特点 Design Features

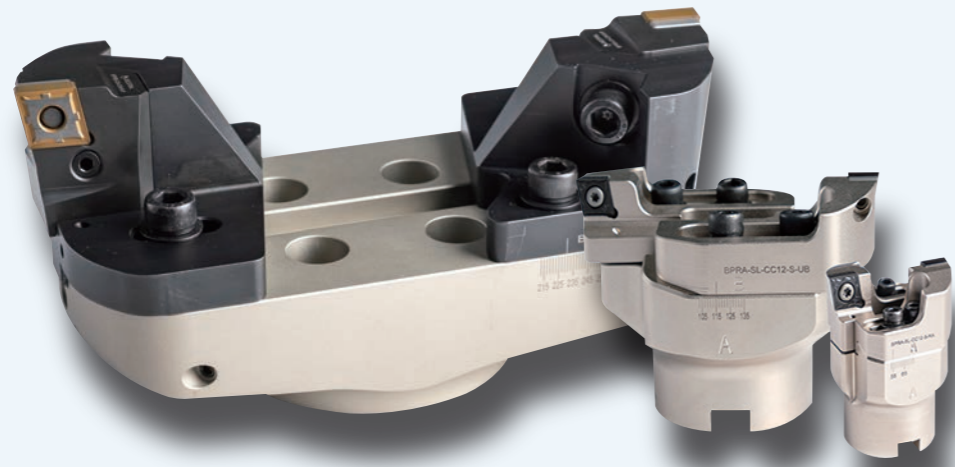

高精度冷却液出水孔，使冷却液位置与刀尖随动，冷却液可直达刃口
High precision coolant outlet hole makes the coolant position follow up with the tool tip reach the cutting edge directly

您的收益

- 冷却液直达刃口，提高刀片使用寿命，降低生产成本；
- 精准冷却可以使铁屑有效排出，避免刮伤工件，提高工件表面光洁度，减少因光度不佳导致的返修成本。

Benefit

- The coolant goes directly to the edge to improve the service life of the insert and reduce the production cost;
- Accurate cooling can make the effective discharge of iron filings, avoid scratching the workpiece, improve the surface finish of the workpiece and reduce the repair cost caused by poor brightness.



粗镗刀体可以通过互换滑块实现阶梯功能，A系列粗镗刀体轴向落差0.4mm，B系列粗镗刀体轴向调整范围1.5mm

Rough boring tools can achieve the step function by exchanging sliders. The axial adjustment range of series is 0.4mm and that of B Series is 1.5mm

您的收益

- 对于单边切削量大的工件，减少走刀次数，提高生产效率，降低制造成本；
- 无需为单边切削量大的工件准备多种刀具，降低刀具采购成本。

Benefit

- For workpieces with large amount of unilateral cutting, the cutting times are reduced to improve production efficiency and reduce manufacturing cost;
- No need to prepare a variety of tools for workpieces with large amount of unilateral cutting, so as to reduce the tool procurement cost.

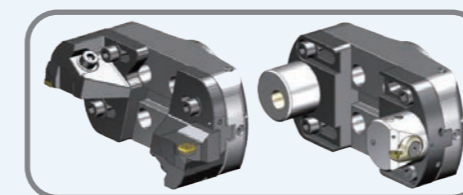

粗镗刀体B系列与精镗刀体B系列选用通装航空铝底座，通过选配不同滑块和刀夹实现粗精镗之间互换使用

The rough boring tools B series and the fine boring tools B series adopt the universal aviation aluminum base, and the interchangeability between rough and fine boring is realized by matching different sliders and cartridges

您的收益

- 通过选用粗精镗对应的滑块及刀夹实现粗精镗切换，降低大直径镗削刀具采购成本。

Benefit

- The conversion of rough and fine boring is realized by selecting the corresponding sliders and cartridges, that reduces the purchase cost of large-diameter boring tool.

命名方式
Naming And Coding Rules

GBT BRA 070085 CC12 S A32A

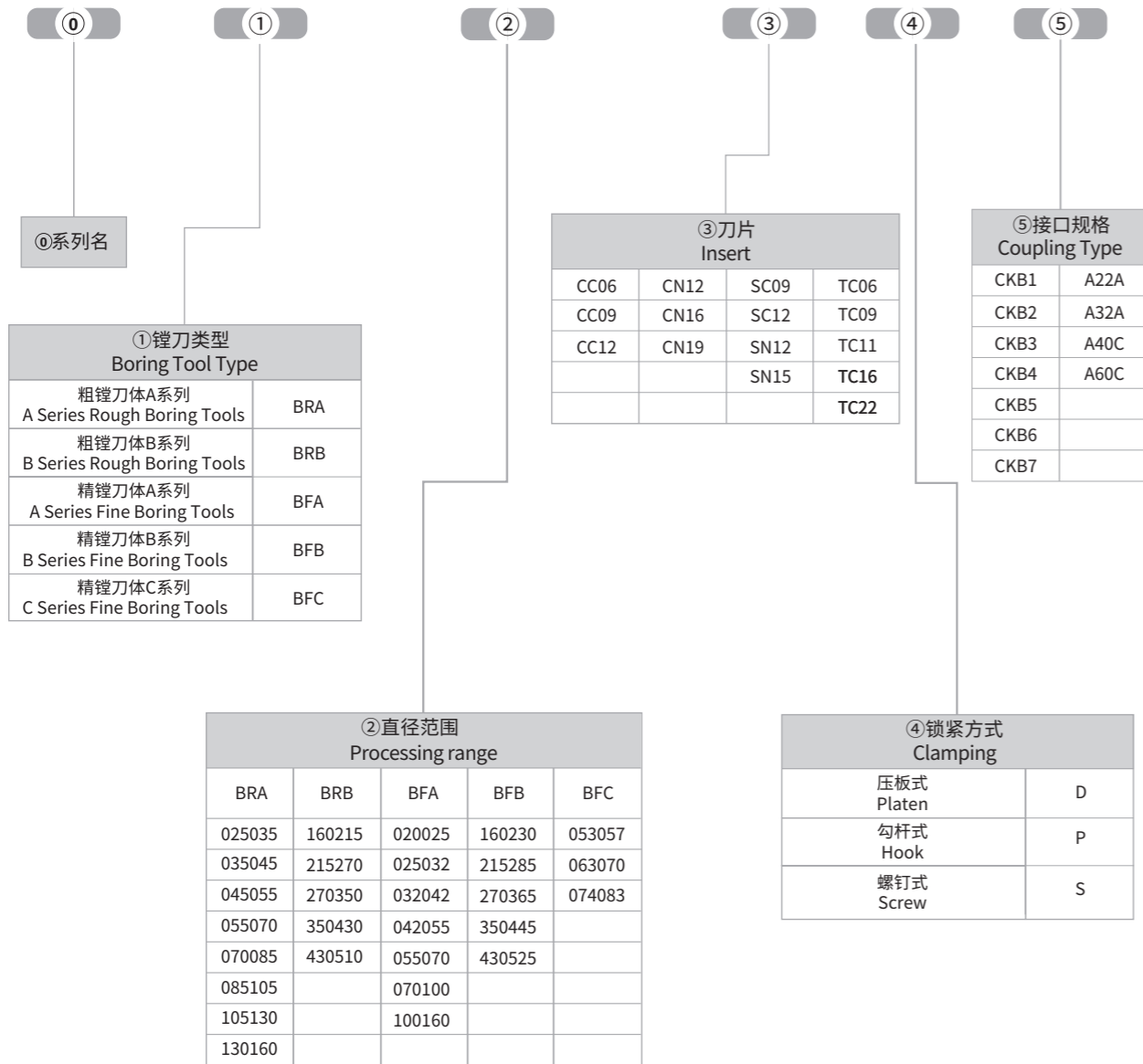

粗镗刀BRA系列 | BRA SERIES

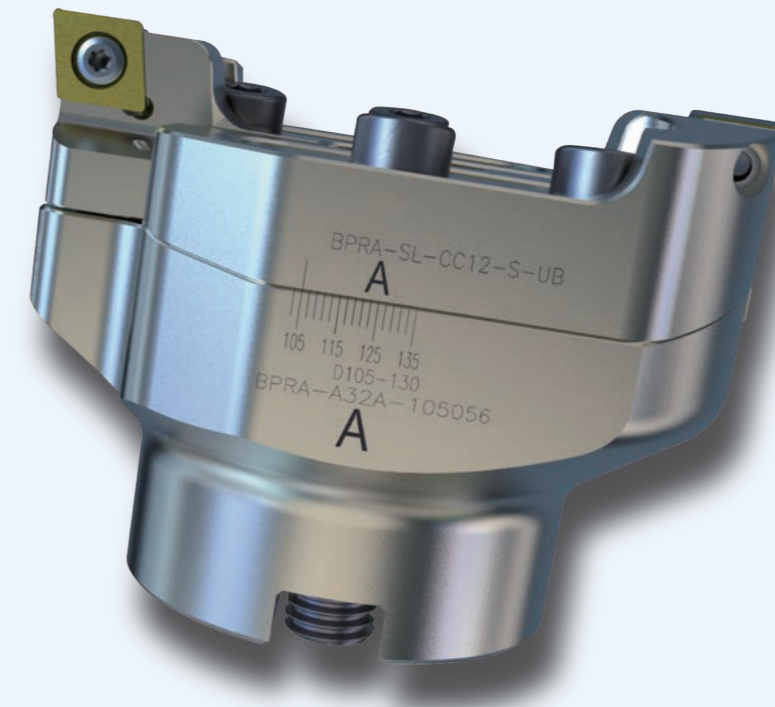

- 适用于Φ25-Φ160mm的孔径加工；
- 加工孔径公差±0.05mm；
- 合金钢刀体配合特殊表面处理提高了刀体刚性及耐磨性；
- 滑块式刀夹装载ISO刀片，市场通用性好。

- Apply to Φ 25- Φ 160mm aperture machining;
- Machining aperture tolerance ± 0.05mm;
- Alloy steel tool body with special surface treatment improves the rigidity and wear resistance;
- The sliding cartridge equipped with ISO inserts is with good market versatility.

BRA-CC系列

BRA-CC SERIES

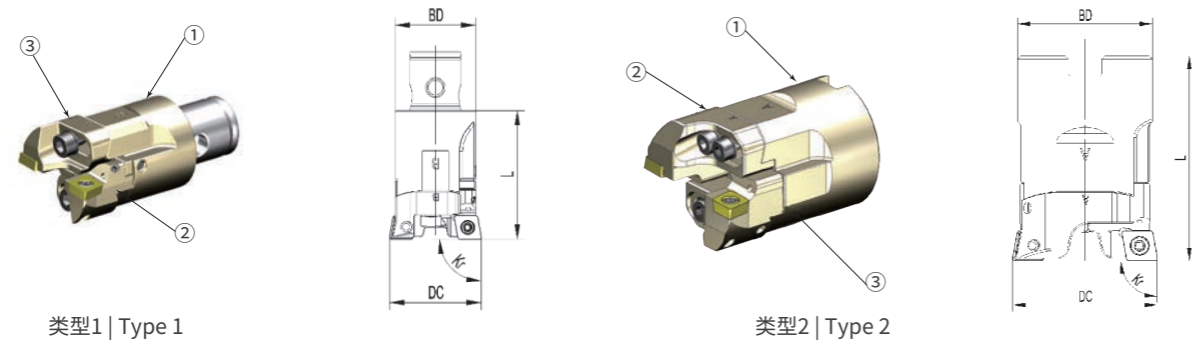

- 内冷却液供应
- CCMT CCGT CCGX CCET CCMW
- 刀片仅做示意

- Internal coolant supply
- CCMT CCGT CCGX CCET CCMW
- The insert is for illustration only

BRA-CC系列滑块式刀夹

BRA-CC SERIES SLIDING CARTRIDGE



- CCMT,CCGT,CCGX,CCET,CCMW
- 刀片仅做示意

- CCMT,CCGT,CCGX,CCET,CCMW
- The insert is for illustration only

技术参数 | Technical parameters

单位 | Unit: mm

订货号 Ordering code	镗削范围 Boring Range(DC)			尺寸 Dimension				刀片 Insert	接口 Coupling	
	Min.	Max.	Adj.	L	BD	Kr	KG		Form	Type
GBT-BRA-025035-CC06-S-CKB2	25	35	5	35	22	90	0.1	CCMT 060204	CKB2	1
GBT-BRA-035045-CC09-S-CKB3	35	45	5	40	31	90	0.22	CCMT 09T308	CKB3	1
GBT-BRA-045055-CC09-S-A22A	45	55	5	65	42	90	0.47	CCMT 09T308	ARB-22A	2
GBT-BRA-055070-CC12-S-A22A	55	70	7.5	68	42	90	0.64	CCMT 120408	ARB-22A	2
GBT-BRA-070085-CC12-S-A32A	70	85	7.5	78	63	90	1.25	CCMT 120408	ARB-32A	2
GBT-BRA-085105-CC12-S-A32A	85	105	10	78	63	90	1.6	CCMT 120408	ARB-32A	2
GBT-BRA-105130-CC12-S-A32A	105	130	12.5	78	63	90	2.13	CCMT 120408	ARB-32A	2
GBT-BRA-130160-CC12-S-A32A	130	160	15	78	63	90	2.67	CCMT 120408	ARB-32A	2

备件 | Accessory

产品型号 Product ID	①	②	③	刀片螺钉扳手 Key(Insert)	刀垫螺钉扳手 Key(Shim)	锁紧螺钉扳手 Key(Screw)	调整螺钉扳手 Key(Adj.)
	刀座 Adaptor	滑块式刀夹A Sliding Cartridge A	滑块式刀夹B Sliding Cartridge B				
GBT-BRA-025035-CC06-S-CKB2	GBT-BPRA-CKB2-025024	GBT-BPRA-SL-CC06-S-OA	GBT-BPRA-SL-CC06-S-OB	242.070.35-GBT	-	241.025.56-GBT	241.013.40-GBT
GBT-BRA-035045-CC09-S-CKB3	GBT-BPRA-CKB3-035026	GBT-BPRA-SL-CC09-S-PA	GBT-BPRA-SL-CC09-S-PB	248.150.10-GBT	-	241.030.63-GBT	246.015.60-GBT
GBT-BRA-045055-CC09-S-A22A	GBT-BPRA-A22A-045046	GBT-BPRA-SL-CC09-S-QA	GBT-BPRA-SL-CC09-S-QB	248.150.10-GBT	-	241.030.63-GBT	246.015.60-GBT
GBT-BRA-055070-CC12-S-A22A	GBT-BPRA-A22A-055046	GBT-BPRA-SL-CC12-S-RA	GBT-BPRA-SL-CC12-S-RB	248.150.10-GBT	-	241.040.70-GBT	246.020.60-GBT
GBT-BRA-070085-CC12-S-A32A	GBT-BPRA-A32A-070056	GBT-BPRA-SL-CC12-S-SA	GBT-BPRA-SL-CC12-S-SB	248.150.10-GBT	241.040.70-GBT	241.050.80-GBT	246.025.60-GBT
GBT-BRA-085105-CC12-S-A32A	GBT-BPRA-A32A-085056	GBT-BPRA-SL-CC12-S-TA	GBT-BPRA-SL-CC12-S-TB	248.150.10-GBT	241.040.70-GBT	241.060.90-GBT	246.030.60-GBT
GBT-BRA-105130-CC12-S-A32A	GBT-BPRA-A32A-105056	GBT-BPRA-SL-CC12-S-UA	GBT-BPRA-SL-CC12-S-UB	248.150.10-GBT	241.040.70-GBT	241.060.90-GBT	246.030.60-GBT
GBT-BRA-130160-CC12-S-A32A	GBT-BPRA-A32A-130056	GBT-BPRA-SL-CC12-S-VA	GBT-BPRA-SL-CC12-S-VB	248.150.10-GBT	241.040.70-GBT	241.060.90-GBT	246.030.60-GBT

可单独订购备件，按需询价。
关于BRA系列刀座请参阅C·19

The spare parts can be ordered separately. Please inquire on demand.
Please refer to C·19 for BRA series Adaptor

技术参数 | Technical parameters

单位 | Unit: mm

订货号 Ordering code	直径范围 Fitting Range	刀片 Insert	夹紧方式 Clamping
GBT-BPRA-SL-CC06-S-OA	25-35	CCMT 060204	S
GBT-BPRA-SL-CC06-S-OB	25-35	CCMT 060204	S
GBT-BPRA-SL-CC09-S-PA	35-45	CCMT 09T308	S
GBT-BPRA-SL-CC09-S-PB	35-45	CCMT 09T308	S
GBT-BPRA-SL-CC09-S-QA	45-55	CCMT 09T308	S
GBT-BPRA-SL-CC09-S-QB	45-55	CCMT 09T308	S
GBT-BPRA-SL-CC12-S-RA	55-70	CCMT 120408	S
GBT-BPRA-SL-CC12-S-RB	55-70	CCMT 120408	S
GBT-BPRA-SL-CC12-S-SA	70-85	CCMT 120408	S
GBT-BPRA-SL-CC12-S-SB	70-85	CCMT 120408	S
GBT-BPRA-SL-CC12-S-TA	85-105	CCMT 120408	S
GBT-BPRA-SL-CC12-S-TB	85-105	CCMT 120408	S
GBT-BPRA-SL-CC12-S-UA	105-130	CCMT 120408	S
GBT-BPRA-SL-CC12-S-UB	105-130	CCMT 120408	S
GBT-BPRA-SL-CC12-S-VA	130-160	CCMT 120408	S
GBT-BPRA-SL-CC12-S-VB	130-160	CCMT 120408	S

转下页 see next page →

BRA-CC系列滑块式刀夹

BRA-CC SERIES SLIDING CARTRIDGE

技术参数 | Technical parameters

单位 | Unit: mm

产品型号 Product ID	备件 Accessory					单独订购 Purchase Separately		
	① 刀片螺钉 Screw(Insert)	② 刀垫 Shim	③ 刀垫螺钉 Screw(Shim)	④ 弹性销 Cotter	⑤ 调整螺钉 Screw(Adj.)	刀片螺钉扳手 Key(Insert)	刀垫螺钉扳手 Key(Shim)	调整螺钉扳手 Key(Adj.)
GBT-BPRA-SL-CC06-S-OA	SFS-2565-GBT	-	-	179.015.08-GBT	-	242.070.35-GBT	-	-
GBT-BPRA-SL-CC06-S-OB	SFS-2565-GBT	-	-	179.015.08-GBT	-	242.070.35-GBT	-	-
GBT-BPRA-SL-CC09-S-PA	SFS 3581-GBT	-	-	179.025.08-GBT	-	248.150.10-GBT	-	-
GBT-BPRA-SL-CC09-S-PB	SFS 3581-GBT	-	-	179.025.08-GBT	-	248.150.10-GBT	-	-
GBT-BPRA-SL-CC09-S-QA	SFS 3581-GBT	-	-	-	253.030.10-GBT	248.150.10-GBT	-	246.015.60-GBT
GBT-BPRA-SL-CC09-S-QB	SFS 3581-GBT	-	-	-	253.030.10-GBT	248.150.10-GBT	-	246.015.60-GBT
GBT-BPRA-SL-CC12-S-RA	ILD 4011-A-GBT	-	-	-	253.040.12-GBT	248.150.10-GBT	-	246.020.60-GBT
GBT-BPRA-SL-CC12-S-RB	ILD 4011-A-GBT	-	-	-	253.040.12-GBT	248.150.10-GBT	-	246.020.60-GBT
GBT-BPRA-SL-CC12-S-SA	ILD 4014-GBT	322.232.02-GBT	512.090.03-GBT	-	253.050.12-GBT	248.150.10-GBT	241.040.70-GBT	246.025.60-GBT
GBT-BPRA-SL-CC12-S-SB	ILD 4014-GBT	322.232.02-GBT	512.090.03-GBT	-	253.050.12-GBT	248.150.10-GBT	241.040.70-GBT	246.025.60-GBT
GBT-BPRA-SL-CC12-S-TA	ILD 4014-GBT	322.232.02-GBT	512.090.03-GBT	-	253.060.16-GBT	248.150.10-GBT	241.040.70-GBT	246.030.60-GBT
GBT-BPRA-SL-CC12-S-TB	ILD 4014-GBT	322.232.02-GBT	512.090.03-GBT	-	253.060.16-GBT	248.150.10-GBT	241.040.70-GBT	246.030.60-GBT
GBT-BPRA-SL-CC12-S-UA	ILD 4014-GBT	322.232.02-GBT	512.090.03-GBT	179.060.16-GBT	-	248.150.10-GBT	241.040.70-GBT	-
GBT-BPRA-SL-CC12-S-UB	ILD 4014-GBT	322.232.02-GBT	512.090.03-GBT	179.060.16-GBT	-	248.150.10-GBT	241.040.70-GBT	-
GBT-BPRA-SL-CC12-S-VA	ILD 4014-GBT	322.232.02-GBT	512.090.03-GBT	179.060.16-GBT	-	248.150.10-GBT	241.040.70-GBT	-
GBT-BPRA-SL-CC12-S-VB	ILD 4014-GBT	322.232.02-GBT	512.090.03-GBT	179.060.16-GBT	-	248.150.10-GBT	241.040.70-GBT	-

可单独订购备件，按需询价。

The spare parts can be ordered separately. Please inquire on demand.

BRA-TC系列

BRA-TC SERIES

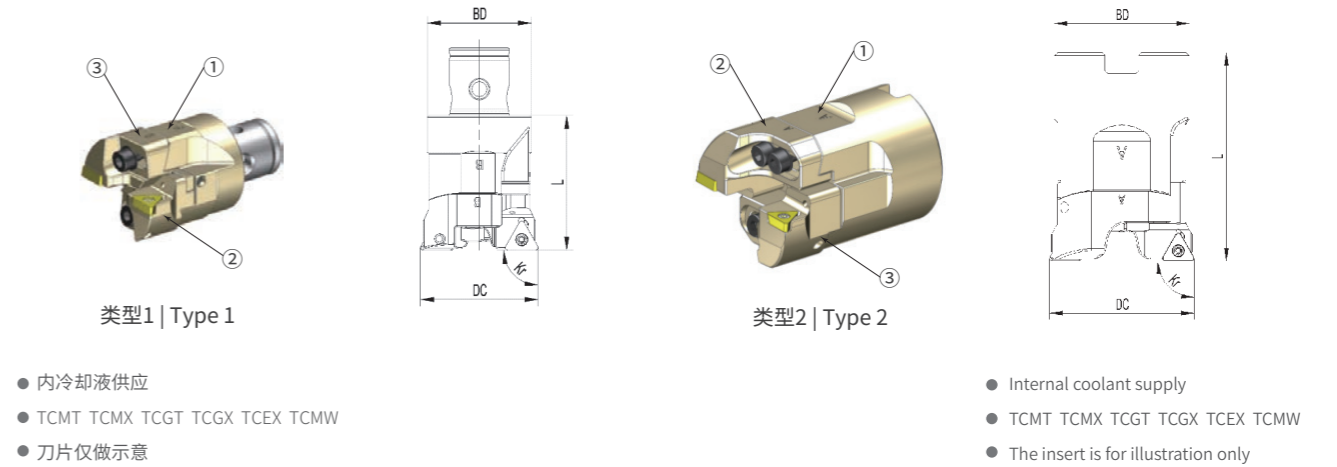

技术参数 | Technical parameters

单位 | Unit: mm

订货号 Ordering code	镗削范围 Boring Range(DC)			尺寸 Dimension				刀片 Insert	接口 Coupling	
	Min.	Max.	Adj.	L	BD	Kr	KG		Form	Type
GBT-BRA-035045-TC11-S-CKB3	35	45	5	40	31	90	0.22	TCMT 110308	CKB3	1
GBT-BRA-045055-TC11-S-A22A	45	55	5	65	42	90	0.47	TCMT 110308	A22A	2
GBT-BRA-055070-TC16-S-A22A	55	70	7.5	68	42	90	0.64	TCMT 16T308	A22A	2
GBT-BRA-070085-TC16-S-A32A	70	85	7.5	78	63	90	1.25	TCMT 16T308	A32A	2
GBT-BRA-085105-TC16-S-A32A	85	105	10	78	63	90	1.6	TCMT 16T308	A32A	2
GBT-BRA-105130-TC16-S-A32A	105	130	12.5	78	63	90	2.13	TCMT 16T308	A32A	2
GBT-BRA-130160-TC16-S-A32A	130	160	15	78	63	90	2.67	TCMT 16T308	A32A	2

备件 | Accessory

产品型号 Product ID	①	②	③				
	刀座 Adaptor	滑块式刀夹A Sliding Cartridge A	滑块式刀夹B Sliding Cartridge B	刀片螺钉扳手 Key(Insert)	刀垫螺钉扳手 Key(Shim)	锁紧螺钉扳手 Key(Screw)	调整螺钉扳手 Key(Adj.)
GBT-BRA-035045-TC11-S-CKB3	GBT-BPRA-CKB3-035026	GBT-BPRA-SL-TC11-S-PA	GBT-BPRA-SL-TC11-S-PB	242.070.35-GBT	-	241.030.63-GBT	246.015.60-GBT
GBT-BRA-045055-TC11-S-A22A	GBT-BPRA-A22A-045046	GBT-BPRA-SL-TC11-S-QA	GBT-BPRA-SL-TC11-S-QB	242.070.35-GBT	-	241.030.63-GBT	246.015.60-GBT
GBT-BRA-055070-TC16-S-A22A	GBT-BPRA-A22A-055046	GBT-BPRA-SL-TC16-S-RA	GBT-BPRA-SL-TC16-S-RB	248.150.10-GBT	-	241.040.70-GBT	246.020.60-GBT
GBT-BRA-070085-TC16-S-A32A	GBT-BPRA-A32A-070056	GBT-BPRA-SL-TC16-S-SA	GBT-BPRA-SL-TC16-S-SB	248.150.10-GBT	241.035.65-GBT	241.050.80-GBT	246.025.60-GBT
GBT-BRA-085105-TC16-S-A32A	GBT-BPRA-A32A-085056	GBT-BPRA-SL-TC16-S-TA	GBT-BPRA-SL-TC16-S-TB	248.150.10-GBT	241.035.65-GBT	241.060.90-GBT	246.030.60-GBT
GBT-BRA-105130-TC16-S-A32A	GBT-BPRA-A32A-105056	GBT-BPRA-SL-TC16-S-UA	GBT-BPRA-SL-TC16-S-UB	248.150.10-GBT	241.035.65-GBT	241.060.90-GBT	246.030.60-GBT
GBT-BRA-130160-TC16-S-A32A	GBT-BPRA-A32A-130056	GBT-BPRA-SL-TC16-S-VA	GBT-BPRA-SL-TC16-S-VB	248.150.10-GBT	241.035.65-GBT	241.060.90-GBT	246.030.60-GBT

可单独订购备件，按需询价。
关于BRA系列刀座请参阅C·19

The spare parts can be ordered separately. Please inquire on demand.
Please refer to C·19 for BRA series Adaptor

BRA-TC系列滑块式刀夹

BRA-TC SERIES SLIDING CARTRIDGE

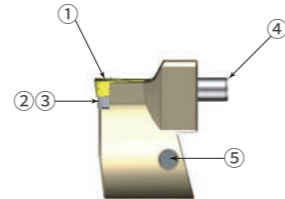

- TCMT TCMX TCGT TCGX TCEX TCMW
- 刀片仅做示意

- TCMT TCMX TCGT TCGX TCEX TCMW
- The insert is for illustration only

技术参数 | Technical parameters

单位 | Unit: mm

订货号 Ordering code	直径范围 Fitting Range	刀片 Insert	夹紧方式 Clamping
GBT-BPRA-SL-TC11-S-PA	35-45	TCMT 110308	S
GBT-BPRA-SL-TC11-S-PB	35-45	TCMT 110308	S
GBT-BPRA-SL-TC11-S-QA	45-55	TCMT 110308	S
GBT-BPRA-SL-TC11-S-QB	45-55	TCMT 110308	S
GBT-BPRA-SL-TC16-S-RA	55-70	TCMT 16T308	S
GBT-BPRA-SL-TC16-S-RB	55-70	TCMT 16T308	S
GBT-BPRA-SL-TC16-S-SA	70-85	TCMT 16T308	S
GBT-BPRA-SL-TC16-S-SB	70-85	TCMT 16T308	S
GBT-BPRA-SL-TC16-S-TA	85-105	TCMT 16T308	S
GBT-BPRA-SL-TC16-S-TB	85-105	TCMT 16T308	S
GBT-BPRA-SL-TC16-S-UA	105-130	TCMT 16T308	S
GBT-BPRA-SL-TC16-S-UB	105-130	TCMT 16T308	S
GBT-BPRA-SL-TC16-S-VA	130-160	TCMT 16T308	S
GBT-BPRA-SL-TC16-S-VB	130-160	TCMT 16T308	S

转下页 see next page →

BRA-TC系列滑块式刀夹

BRA-TC SERIES SLIDING CARTRIDGE

技术参数 | Technical parameters

单位 | Unit: mm

产品型号 Product ID	备件 Accessory					单独订购 Purchase Separately		
	① 刀片螺钉 Screw(Insert)	② 刀垫 Shim	③ 刀垫螺钉 Screw(Shim)	④ 弹性销 Cotter	⑤ 调整螺钉 Screw(Adj.)	刀片螺钉扳手 Key(Insert)	刀垫螺钉扳手 Key(Shim)	调整螺钉扳手 Key(Adj.)
GBT-BPRA-SL-TC11-S-PA	SFS-2565-GBT	-	-	179.025.08-GBT	-	242.070.35-GBT	-	-
GBT-BPRA-SL-TC11-S-PB	SFS-2565-GBT	-	-	179.025.08-GBT	-	242.070.35-GBT	-	-
GBT-BPRA-SL-TC11-S-QA	SFS-2565-GBT	-	-	-	253.030.10-GBT	242.070.35-GBT	-	246.015.60-GBT
GBT-BPRA-SL-TC11-S-QB	SFS-2565-GBT	-	-	-	253.030.10-GBT	242.070.35-GBT	-	246.015.60-GBT
GBT-BPRA-SL-TC16-S-RA	ILD3510-GBT	-	-	-	253.040.12-GBT	248.150.10-GBT	-	246.020.60-GBT
GBT-BPRA-SL-TC16-S-RB	ILD3510-GBT	-	-	-	253.040.12-GBT	248.150.10-GBT	-	246.020.60-GBT
GBT-BPRA-SL-TC16-S-SA	SFS_3512-GBT	322.320.01-GBT	512.090.01-GBT	-	253.050.12-GBT	248.150.10-GBT	241.035.65-GBT	246.025.60-GBT
GBT-BPRA-SL-TC16-S-SB	SFS_3512-GBT	322.320.01-GBT	512.090.01-GBT	-	253.050.12-GBT	248.150.10-GBT	241.035.65-GBT	246.025.60-GBT
GBT-BPRA-SL-TC16-S-TA	SFS_3512-GBT	322.320.01-GBT	512.090.01-GBT	-	253.060.16-GBT	248.150.10-GBT	241.035.65-GBT	246.030.60-GBT
GBT-BPRA-SL-TC16-S-TB	SFS_3512-GBT	322.320.01-GBT	512.090.01-GBT	-	253.060.16-GBT	248.150.10-GBT	241.035.65-GBT	246.030.60-GBT
GBT-BPRA-SL-TC16-S-UA	SFS_3512-GBT	322.320.01-GBT	512.090.01-GBT	179.060.16-GBT	-	248.150.10-GBT	241.035.65-GBT	-
GBT-BPRA-SL-TC16-S-UB	SFS_3512-GBT	322.320.01-GBT	512.090.01-GBT	179.060.16-GBT	-	248.150.10-GBT	241.035.65-GBT	-
GBT-BPRA-SL-TC16-S-VA	SFS_3512-GBT	322.320.01-GBT	512.090.01-GBT	179.060.16-GBT	-	248.150.10-GBT	241.035.65-GBT	-
GBT-BPRA-SL-TC16-S-VB	SFS_3512-GBT	322.320.01-GBT	512.090.01-GBT	179.060.16-GBT	-	248.150.10-GBT	241.035.65-GBT	-

可单独订购备件，按需询价。

The spare parts can be ordered separately. Please inquire on demand.

BRA-SC系列

BRA-SC SERIES

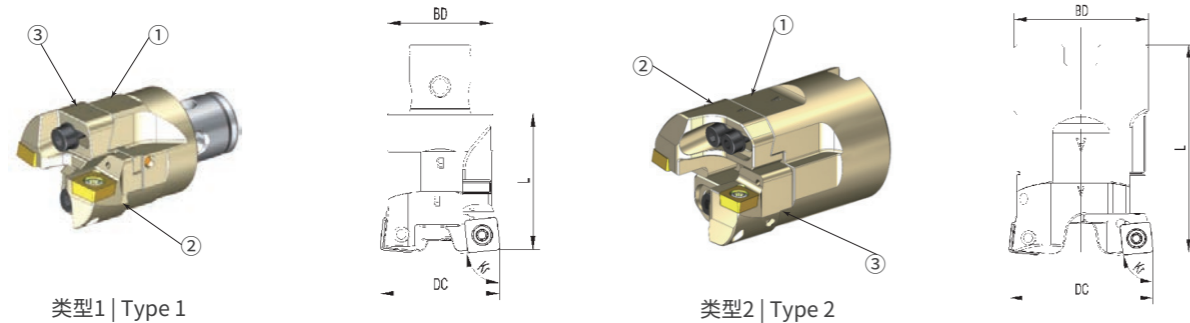

类型1 | Type 1

类型2 | Type 2

- 内冷却液供应
- SCMT SCGX SCMW
- 刀片仅做示意

- Internal coolant supply
- SCMT SCGX SCMW
- The insert is for illustration only

BRA-SC系列滑块式刀夹

BRA-SC SERIES SLIDING CARTRIDGE

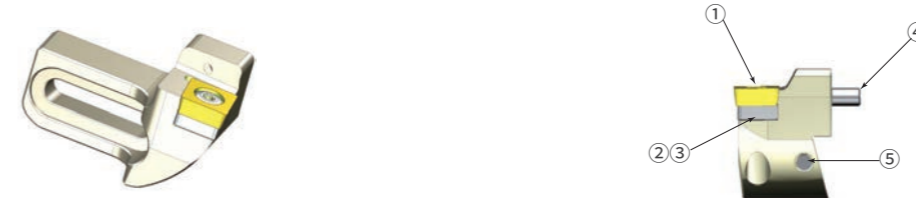

- SCMT SCGX SCMW
- 刀片仅做示意

- SCMT SCGX SCMW
- The insert is for illustration only

技术参数 | Technical parameters

单位 | Unit: mm

订货号 Ordering code	镗削范围 Boring Range(DC)			尺寸 Dimension				刀片 Insert	接口 Coupling	
	Min.	Max.	Adj.	L	BD	Kr	KG		Form	Type
GBT-BRA-035045-SC09-S-CKB3	35	45	5	40	31	84	0.22	SCMT 09T308	CKB3	1
GBT-BRA-045055-SC09-S-A22A	45	55	5	65	42	84	0.47	SCMT 09T308	A22A	2
GBT-BRA-055070-SC12-S-A22A	55	70	7.5	68	42	84	0.64	SCMT 120408	A22A	2
GBT-BRA-070085-SC12-S-A32A	70	85	7.5	78	63	84	1.25	SCMT 120408	A32A	2
GBT-BRA-085105-SC12-S-A32A	85	105	10	78	63	84	1.6	SCMT 120408	A32A	2
GBT-BRA-105130-SC12-S-A32A	105	130	12.5	78	63	84	2.13	SCMT 120408	A32A	2
GBT-BRA-130160-SC12-S-A32A	130	160	15	78	63	84	2.67	SCMT 120408	A32A	2

备件 | Accessory

产品型号 Product ID	①	②	③	刀片螺钉扳手 Key(Insert)	刀垫螺钉扳手 Key(Shim)	锁紧螺钉扳手 Key(Screw)	调整螺钉扳手 Key(Adj.)
	刀座 Adaptor	滑块式刀夹A Sliding Cartridge A	滑块式刀夹B Sliding Cartridge B				
GBT-BRA-035045-SC09-S-CKB3	GBT-BPRA-CKB3-035026	GBT-BPRA-SL-SC09-S-PA	GBT-BPRA-SL-SC09-S-PB	248.150.10-GBT	-	241.030.63-GBT	246.015.60-GBT
GBT-BRA-045055-SC09-S-A22A	GBT-BPRA-A22A-045046	GBT-BPRA-SL-SC09-S-QA	GBT-BPRA-SL-SC09-S-QB	248.150.10-GBT	-	241.030.63-GBT	246.015.60-GBT
GBT-BRA-055070-SC12-S-A22A	GBT-BPRA-A22A-055046	GBT-BPRA-SL-SC12-S-RA	GBT-BPRA-SL-SC12-S-RB	248.150.10-GBT	-	241.040.70-GBT	246.020.60-GBT
GBT-BRA-070085-SC12-S-A32A	GBT-BPRA-A32A-070056	GBT-BPRA-SL-SC12-S-SA	GBT-BPRA-SL-SC12-S-SB	248.150.10-GBT	241.040.70-GBT	241.050.80-GBT	246.025.60-GBT
GBT-BRA-085105-SC12-S-A32A	GBT-BPRA-A32A-085056	GBT-BPRA-SL-SC12-S-TA	GBT-BPRA-SL-SC12-S-TB	248.150.10-GBT	241.040.70-GBT	241.060.90-GBT	246.030.60-GBT
GBT-BRA-105130-SC12-S-A32A	GBT-BPRA-A32A-105056	GBT-BPRA-SL-SC12-S-UA	GBT-BPRA-SL-SC12-S-UB	248.150.10-GBT	241.040.70-GBT	241.060.90-GBT	246.030.60-GBT
GBT-BRA-130160-SC12-S-A32A	GBT-BPRA-A32A-130056	GBT-BPRA-SL-SC12-S-VA	GBT-BPRA-SL-SC12-S-VB	248.150.10-GBT	241.040.70-GBT	241.060.90-GBT	246.030.60-GBT

可单独订购备件，按需询价。
关于BRA系列刀座请参阅C·19

The spare parts can be ordered separately. Please inquire on demand.
Please refer to C·19 for BRA series Adaptor

技术参数 | Technical parameters

单位 | Unit: mm

订货号 Ordering code	直径范围 Fitting Range	刀片 Insert	夹紧方式 Clamping
GBT-BPRA-SL-SC09-S-PA	35-45	SCMT 09T308	S
GBT-BPRA-SL-SC09-S-PB	35-45	SCMT 09T308	S
GBT-BPRA-SL-SC09-S-QA	45-55	SCMT 09T308	S
GBT-BPRA-SL-SC09-S-QB	45-55	SCMT 09T308	S
GBT-BPRA-SL-SC12-S-RA	55-70	SCMT 120408	S
GBT-BPRA-SL-SC12-S-RB	55-70	SCMT 120408	S
GBT-BPRA-SL-SC12-S-SA	70-85	SCMT 120408	S
GBT-BPRA-SL-SC12-S-SB	70-85	SCMT 120408	S
GBT-BPRA-SL-SC12-S-TA	85-105	SCMT 120408	S
GBT-BPRA-SL-SC12-S-TB	85-105	SCMT 120408	S
GBT-BPRA-SL-SC12-S-UA	105-130	SCMT 120408	S
GBT-BPRA-SL-SC12-S-UB	105-130	SCMT 120408	S
GBT-BPRA-SL-SC12-S-VA	130-160	SCMT 120408	S
GBT-BPRA-SL-SC12-S-VB	130-160	SCMT 120408	S

转下页 see next page →

BRA-SC系列滑块式刀夹

BRA-SC SERIES SLIDING CARTRIDGE

技术参数 | Technical parameters

单位 | Unit: mm

产品型号 Product ID	备件 Accessory					单独订购 Purchase Separately		
	① 刀片螺钉 Screw(Insert)	② 刀垫 Shim	③ 刀垫螺钉 Screw(Shim)	④ 弹性销 Cotter	⑤ 调整螺钉 Screw(Adj.)	 刀片螺钉扳手 Key(Insert)	 刀垫螺钉扳手 Key(Shim)	 调整螺钉扳手 Key(Adj.)
GBT-BPRA-SL-SC09-S-PA	SFS 3581-GBT	-	-	179.025.08-GBT	-	248.150.10-GBT	-	-
GBT-BPRA-SL-SC09-S-PB	SFS 3581-GBT	-	-	179.025.08-GBT	-	248.150.10-GBT	-	-
GBT-BPRA-SL-SC09-S-QA	SFS 3581-GBT	-	-	-	253.030.10-GBT	248.150.10-GBT	-	246.015.60-GBT
GBT-BPRA-SL-SC09-S-QB	SFS 3581-GBT	-	-	-	253.030.10-GBT	248.150.10-GBT	-	246.015.60-GBT
GBT-BPRA-SL-SC12-S-RA	ILD 4011-A-GBT	-	-	-	253.040.12-GBT	248.150.10-GBT	-	246.020.60-GBT
GBT-BPRA-SL-SC12-S-RB	ILD 4011-A-GBT	-	-	-	253.040.12-GBT	248.150.10-GBT	-	246.020.60-GBT
GBT-BPRA-SL-SC12-S-SA	ILD 4014-GBT	322.420.02-GBT	512.090.03-GBT	-	253.050.12-GBT	248.150.10-GBT	241.040.70-GBT	246.025.60-GBT
GBT-BPRA-SL-SC12-S-SB	ILD 4014-GBT	322.420.02-GBT	512.090.03-GBT	-	253.050.12-GBT	248.150.10-GBT	241.040.70-GBT	246.025.60-GBT
GBT-BPRA-SL-SC12-S-TA	ILD 4014-GBT	322.420.02-GBT	512.090.03-GBT	-	253.060.16-GBT	248.150.10-GBT	241.040.70-GBT	246.030.60-GBT
GBT-BPRA-SL-SC12-S-TB	ILD 4014-GBT	322.420.02-GBT	512.090.03-GBT	-	253.060.16-GBT	248.150.10-GBT	241.040.70-GBT	246.030.60-GBT
GBT-BPRA-SL-SC12-S-UA	ILD 4014-GBT	322.420.02-GBT	512.090.03-GBT	179.060.16-GBT	-	248.150.10-GBT	241.040.70-GBT	-
GBT-BPRA-SL-SC12-S-UB	ILD 4014-GBT	322.420.02-GBT	512.090.03-GBT	179.060.16-GBT	-	248.150.10-GBT	241.040.70-GBT	-
GBT-BPRA-SL-SC12-S-VA	ILD 4014-GBT	322.420.02-GBT	512.090.03-GBT	179.060.16-GBT	-	248.150.10-GBT	241.040.70-GBT	-
GBT-BPRA-SL-SC12-S-VB	ILD 4014-GBT	322.420.02-GBT	512.090.03-GBT	179.060.16-GBT	-	248.150.10-GBT	241.040.70-GBT	-

可单独订购备件，按需询价。

The spare parts can be ordered separately. Please inquire on demand.

BRA系列刀座

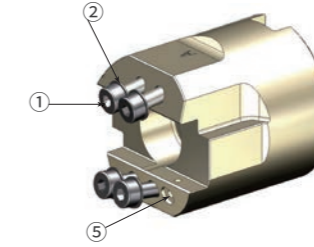
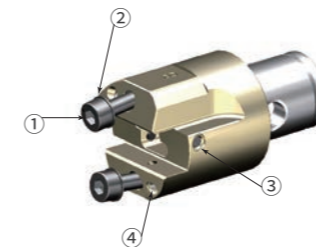

BRA SERIES ADAPTOR



技术参数 | Technical parameters

单位 | Unit: mm

订货号 Ordering code	直径范围 Fitting Range	接口 Coupling
GBT-BPRA-CKB2-025024	25-35	CKB2
GBT-BPRA-CKB3-035026	35-45	CKB3
GBT-BPRA-A22A-045046	45-55	A22A
GBT-BPRA-A22A-055046	55-70	A22A
GBT-BPRA-A32A-070056	70-85	A32A
GBT-BPRA-A32A-085056	85-105	A32A
GBT-BPRA-A32A-105056	105-130	A32A
GBT-BPRA-A32A-130056	130-160	A32A

产品型号 Product ID	备件 Accessory					单独订购 Purchase Separately	
	① 锁紧螺钉 Screw(Insert)	② 弹簧垫圈 Shim	③ 调整螺钉 Screw(Adj.)	④ 堵丝 Nozzle	⑤ 水堵 Screw	 锁紧螺钉扳手 Key(Screw)	 调整螺钉扳手 Key(Adj.)
GBT-BPRA-CKB2-025024	113.030.10-GBT	136.030.03-GBT	253.025.08-GBT	251.020.02-GBT	-	241.025.56-GBT	241.013.40-GBT
GBT-BPRA-CKB3-035026	113.040.16-GBT	136.040.04-GBT	253.030.10-GBT	251.030.03-GBT	-	241.030.63-GBT	246.015.60-GBT
GBT-BPRA-A22A-045046	113.040.16-GBT	136.040.04-GBT	-	-	643.020.09-GBT	241.030.63-GBT	-
GBT-BPRA-A22A-055046	113.050.20-GBT	136.050.05-GBT	-	-	643.020.09-GBT	241.040.70-GBT	-
GBT-BPRA-A32A-070056	113.060.20-GBT	136.060.07-GBT	-	251.040.04-GBT	643.020.09-GBT	241.050.80-GBT	-
GBT-BPRA-A32A-085056	113.080.25-GBT	136.080.09-GBT	-	251.040.04-GBT	643.020.09-GBT	241.060.90-GBT	-
GBT-BPRA-A32A-105056	113.080.25-GBT	136.080.09-GBT	253.060.20-GBT	251.040.04-GBT	-	241.060.90-GBT	246.030.60-GBT
GBT-BPRA-A32A-130056	113.080.25-GBT	136.080.09-GBT	253.060.25-GBT	251.040.04-GBT	-	241.060.90-GBT	246.030.60-GBT

可单独订购备件，按需询价。

The spare parts can be ordered separately. Please inquire on demand.

粗镗刀BRB系列 | BRB SERIES

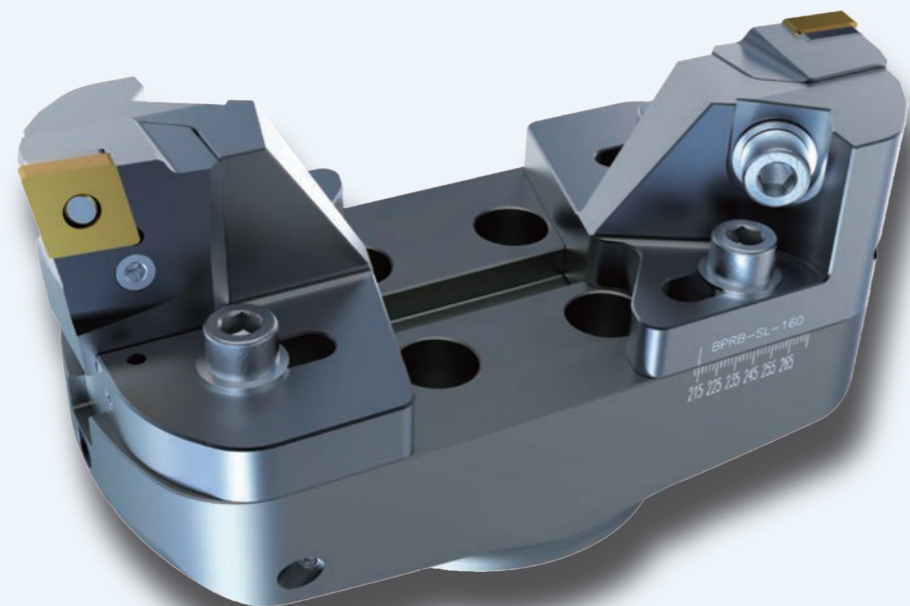

- 适用于Φ160-Φ510mm的孔径加工;
- 加工孔径公差±0.05mm;
- 航空铝桥架具有较轻的重量可减少主轴负载;
- 刀夹装载ISO刀片, 市场通用性好;
- 可进行轴向及径向双向调节。

- Apply to Φ 160- Φ 510mm aperture machining;
- Machining aperture tolerance ± 0.05mm;
- Aviation aluminum bridge with less weight can reduce the spindle load;
- The cartridge equipped with ISO inserts is with good market versatility;
- Bidirectional adjustment in axial and radial is available.

BRB-CC-S系列

BRB-CC-S SERIES

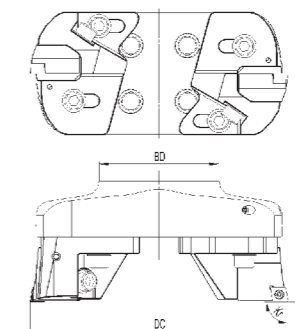
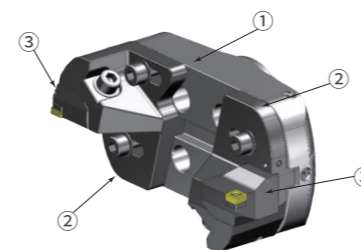

- 内冷却液供应
- CCMT CCGT CCGX CCET CCMW
- 刀片仅做示意

- Internal coolant supply
- CCMT CCGT CCGX CCET CCMW
- The insert is for illustration only

技术参数 | Technical parameters

单位 | Unit: mm

订货号 Ordering code	镗削范围 Boring Range(DC)			尺寸 Dimension					刀片 Insert	夹紧方式 Clamping	接口 Coupling
	Min.	Max.	Adj.	L	BD	WH	Kr	KG			
GBT-BRB-160215-CC12-S-A40C	160	215	27.5	105	100	104	90	4.39	CCMT 120408	S	A40C
GBT-BRB-215270-CC12-S-A40C	215	270	27.5	105	100	104	90	5	CCMT 120408	S	A40C

备件 | Accessory

产品型号 Product ID	①	②	③				
	桥架式刀座 Bridge Adaptor	滑块 Slide	刀夹 Cartridge	刀片螺钉扳手 Key(Insert)	刀垫螺钉扳手 Key(Shim)	锁紧螺钉扳手 Key(Screw)	调整螺钉扳手 Key(Adj.)
GBT-BRB-160215-CC12-S-A40C	GBT-BPDB-A40C-160050	GBT-BPRB-SL-160	GBT-BPRB-CA-CC12-S	248.150.10-GBT	241.040.70-GBT	241.080.00-GBT	246.030.60-GBT
GBT-BRB-215270-CC12-S-A40C	GBT-BPDB-A40C-215050	GBT-BPRB-SL-160	GBT-BPRB-CA-CC12-S	248.150.10-GBT	241.040.70-GBT	241.080.00-GBT	246.030.60-GBT

可单独订购备件, 按需询价。
关于BRB系列桥架式刀座请参阅C·44
关于BRB系列滑块请参阅C·46

The spare parts can be ordered separately. Please inquire on demand.
Please refer to C·44 for BRB series Bridge Adaptor
Please refer to C·46 for BRB series Sliding

BRB-CC-S系列

BRB-CC-S SERIES

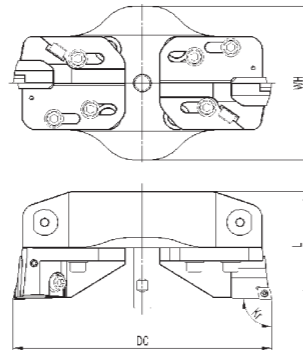
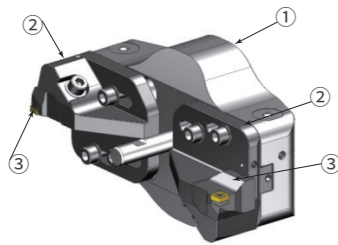

- 内冷却液供应
- CCMT CCGT CCGX CCET CCMW
- 刀片仅做示意

- Internal coolant supply
- CCMT CCGT CCGX CCET CCMW
- The insert is for illustration only

BRB-CC-S系列刀夹

BRB-CC-S SERIES CARTRIDGE

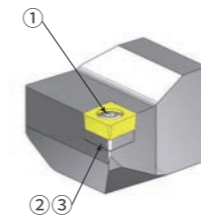

- CCMT CCGT CCGX CCET CCMW
- 刀片仅做示意

- CCMT CCGT CCGX CCET CCMW
- The insert is for illustration only

技术参数 | Technical parameters

单位 | Unit: mm

订货号 Ordering code	镗削范围 Boring Range(DC)			尺寸 Dimension					刀片 Insert	夹紧方式 Clamping	接口 Coupling
	Min.	Max.	Adj.	L	BD	WH	Kr	KG			
GBT-BRB-270350-CC12-S-A60C	270	350	40	115	-	140	90	7.8	CCMT 120408	S	A60C
GBT-BRB-350430-CC12-S-A60C	350	430	40	120	-	140	90	9.4	CCMT 120408	S	A60C
GBT-BRB-430510-CC12-S-A60C	430	510	40	125	-	140	90	11.1	CCMT 120408	S	A60C

备件 | Accessory

产品型号 Product ID	①	②	③				
	桥架式刀座 Brigde Adaptor	滑块 Slide	刀夹 Cartridge	刀片螺钉扳手 Key(Insert)	刀垫螺钉扳手 Key(Shim)	锁紧螺钉扳手 Key(Screw)	调整螺钉扳手 Key(Adj.)
GBT-BRB-270350-CC12-S-A60C	GBT-BPDB-A60C-270060	GBT-BPRB-SL-270	GBT-BPRB-CA-CC12-S	248.150.10-GBT	241.040.70-GBT	241.080.00-GBT	246.030.60-GBT
GBT-BRB-350430-CC12-S-A60C	GBT-BPDB-A60C-350065	GBT-BPRB-SL-270	GBT-BPRB-CA-CC12-S	248.150.10-GBT	241.040.70-GBT	241.080.00-GBT	246.030.60-GBT
BGBT-RB-430510-CC12-S-A60C	GBT-BPDB-A60C-430070	GBT-BPRB-SL-270	GBT-BPRB-CA-CC12-S	248.150.10-GBT	241.040.70-GBT	241.080.00-GBT	246.030.60-GBT

可单独订购备件，按需询价。

The spare parts can be ordered separately. Please inquire on demand.

关于BRB系列桥架式刀座请参阅C·45

Please refer to C·45 for BRB series Brigde Adaptor

关于BRB系列滑块请参阅C·46

Please refer to C·46 for BRB series Sliding

技术参数 | Technical parameters

单位 | Unit: mm

订货号 Ordering code	刀片 Insert	夹紧方式 Clamping
GBT-BPRB-CA-CC12-S	CC..120408	S

备件 | Accessory

单独订购 | Purchase Separately

产品型号 Product ID	①	②	③	
	刀片螺钉 Screw(Insert)	刀垫 Shim	刀垫螺钉 Screw(Shim)	刀片螺钉扳手 Key(Insert)
GBT-BPRB-CA-CC12-S	LID 4014-GBT	322.232.02-GBT	512.090.03-GBT	248.150.10-GBT

可单独订购备件，按需询价。

The spare parts can be ordered separately. Please inquire on demand.

BRB-TC-S系列

BRB-TC-S SERIES

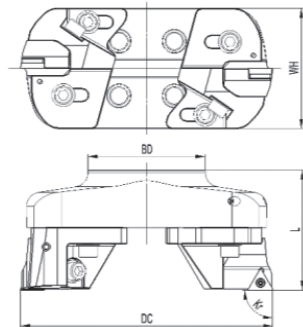
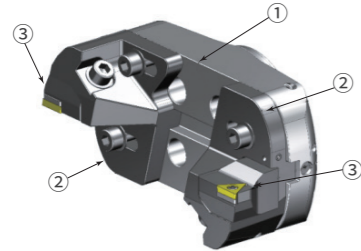

- 内冷却液供应
- TCMT TCMX TCGT TCGX TCEX TCMW
- 刀片仅做示意

- Internal coolant supply
- TCMT TCMX TCGT TCGX TCEX TCMW
- The insert is for illustration only

BRB-TC-S系列

BRB-TC-S SERIES

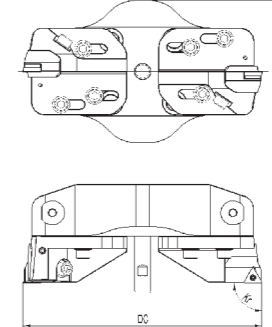
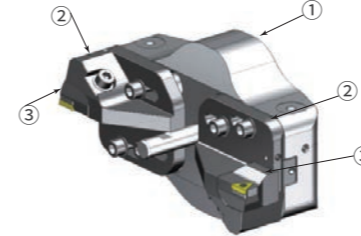

- 内冷却液供应
- TCMT TCMX TCGT TCGX TCEX TCMW
- 刀片仅做示意

- Internal coolant supply
- TCMT TCMX TCGT TCGX TCEX TCMW
- The insert is for illustration only

技术参数 | Technical parameters

单位 | Unit: mm

订货号 Ordering code	镗削范围 Boring Range(DC)			尺寸 Dimension					刀片 Insert	夹紧方式 Clamping	接口 Coupling
	Min.	Max.	Adj.	L	BD	WH	Kr	KG			
GBT-BRB-160215-TC16-S-A40C	160	215	27.5	105	100	104	90	4.39	TCMT 16T308	S	A40C
GBT-BRB-215270-TC16-S-A40C	215	270	27.5	105	100	104	90	5	TCMT 16T308	S	A40C
GBT-BRB-160215-TC22-S-A40C	160	215	27.5	105	100	104	90	4.39	TCMT 220408	S	A40C
GBT-BRB-215270-TC22-S-A40C	215	270	27.5	105	100	104	90	5	TCMT 220408	S	A40C

备件 | Accessory

产品型号 Product ID	①	②	③				
	桥架式刀座 Brigde Adaptor	滑块 Slide	刀夹 Cartridge	刀片螺钉扳手 Key(Insert)	刀垫螺钉扳手 Key(Shim)	锁紧螺钉扳手 Key(Screw)	调整螺钉扳手 Key(Adj.)
GBT-BRB-160215-TC16-S-A40C	GBT-BPDB-A40C-160050	GBT-BPRB-SL-160	GBT-BPRB-CA-TC16-S	248.150.10-GBT	241.035.65-GBT	241.080.00-GBT	246.030.60-GBT
GBT-BRB-215270-TC16-S-A40C	GBT-BPDB-A40C-215050	GBT-BPRB-SL-160	GBT-BPRB-CA-TC16-S	248.150.10-GBT	241.035.65-GBT	241.080.00-GBT	246.030.60-GBT
GBT-BRB-160215-TC22-S-A40C	GBT-BPDB-A40C-160050	GBT-BPRB-SL-160	GBT-BPRB-CA-TC22-S	248.150.10-GBT	241.040.70-GBT	241.080.00-GBT	246.030.60-GBT
GBT-BRB-215270-TC22-S-A40C	GBT-BPDB-A40C-215050	GBT-BPRB-SL-160	GBT-BPRB-CA-TC22-S	248.150.10-GBT	241.040.70-GBT	241.080.00-GBT	246.030.6-GBT0

可单独订购备件，按需询价。
关于BRB系列桥架式刀座请参阅C·44
关于BRB系列滑块请参阅C·46

The spare parts can be ordered separately. Please inquire on demand.
Please refer to C·44 for BRB series Brigde Adaptor
Please refer to C·46 for BRB series Sliding

技术参数 | Technical parameters

单位 | Unit: mm

订货号 Ordering code	镗削范围 Boring Range(DC)			尺寸 Dimension					刀片 Insert	夹紧方式 Clamping	接口 Coupling
	Min.	Max.	Adj.	L	BD	WH	Kr	KG			
GBT-BRB-270350-TC16-S-A60C	270	350	40	115	-	140	90	7.8	TCMT 16T308	S	A60C
GBT-BRB-350430-TC16-S-A60C	350	430	40	120	-	140	90	9.4	TCMT 16T308	S	A60C
GBT-BRB-430510-TC16-S-A60C	430	510	40	125	-	140	90	11.1	TCMT 16T308	S	A60C
GBT-BRB-270350-TC22-S-A60C	270	350	40	115	-	140	90	7.8	TCMT 220408	S	A60C
GBT-BRB-350430-TC22-S-A60C	350	430	40	120	-	140	90	9.4	TCMT 220408	S	A60C
GBT-BRB-430510-TC22-S-A60C	430	510	40	125	-	140	90	11.1	TCMT 220408	S	A60C

备件 | Accessory

产品型号 Product ID	①	②	③				
	桥架式刀座 Brigde Adaptor	滑块 Slide	刀夹 Cartridge	刀片螺钉扳手 Key(Insert)	刀垫螺钉扳手 Key(Shim)	锁紧螺钉扳手 Key(Screw)	调整螺钉扳手 Key(Adj.)
GBT-BRB-270350-TC16-S-A60C	GBT-BPDB-A60C-270060	GBT-BPRB-SL-270	GBT-BPRB-CA-TC16-S	248.150.10-GBT	241.035.65-GBT	241.080.00-GBT	246.030.60-GBT
GBT-BRB-350430-TC16-S-A60C	GBT-BPDB-A60C-350065	GBT-BPRB-SL-270	GBT-BPRB-CA-TC16-S	248.150.10-GBT	241.035.65-GBT	241.080.00-GBT	246.030.60-GBT
GBT-BRB-430510-TC16-S-A60C	GBT-BPDB-A60C-430070	GBT-BPRB-SL-270	GBT-BPRB-CA-TC16-S	248.150.10-GBT	241.035.65-GBT	241.080.00-GBT	246.030.60-GBT
GBT-BRB-270350-TC22-S-A60C	GBT-BPDB-A60C-270060	GBT-BPRB-SL-270	GBT-BPRB-CA-TC22-S	248.150.10-GBT	241.040.70-GBT	241.080.00-GBT	246.030.60-GBT
GBT-BRB-350430-TC22-S-A60C	GBT-BPDB-A60C-350065	GBT-BPRB-SL-270	GBT-BPRB-CA-TC22-S	248.150.10-GBT	241.040.70-GBT	241.080.00-GBT	246.030.60-GBT
GBT-BRB-430510-TC22-S-A60C	GBT-BPDB-A60C-430070	GBT-BPRB-SL-270	GBT-BPRB-CA-TC22-S	248.150.10-GBT	241.040.70-GBT	241.080.00-GBT	246.030.60-GBT

可单独订购备件，按需询价。
关于BRB系列桥架式刀座请参阅C·45
关于BRB系列滑块请参阅C·46

The spare parts can be ordered separately. Please inquire on demand.
Please refer to C·45 for BRB series Brigde Adaptor
Please refer to C·46 for BRB series Sliding

BRB-TC-S系列刀夹

BRB-TC-S SERIES CARTRIDGE

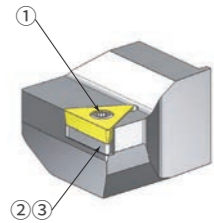

- TCMT TCMX TCGT TCGX TCEX TCMW
- 刀片仅做示意

- TCMT TCMX TCGT TCGX TCEX TCMW
- The insert is for illustration only

技术参数 | Technical parameters

单位 | Unit: mm

订货号 Ordering code	刀片 Insert	夹紧方式 Clamping
GBT-BPRB-CA-TC16-S	TC..16T308	S
GBT-BPRB-CA-TC22-S	TC..220408	S

产品型号 Product ID	备件 Accessory			单独订购 Purchase Separately
	① 刀片螺钉 Screw(Insert)	② 刀垫 Shim	③ 刀垫螺钉 Screw(Shim)	刀片螺钉扳手 Key(Insert)
GBT-BPRB-CA-TC16-S	SFS_3512-GBT	322.320.01-GBT	512.090.01-GBT	248.150.10-GBT
GBT-BPRB-CA-TC22-S	ILD 4014-GBT	322.320.02-GBT	512.090.03-GBT	248.150.10-GBT

可单独订购备件，按需询价。

The spare parts can be ordered separately. Please inquire on demand.

BRB-SC-S系列

BRB-SC-S SERIES

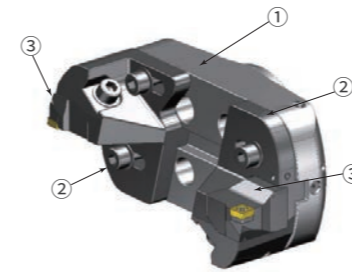

- 内冷却液供应
- SCMT SCGX SCMW
- 刀片仅做示意

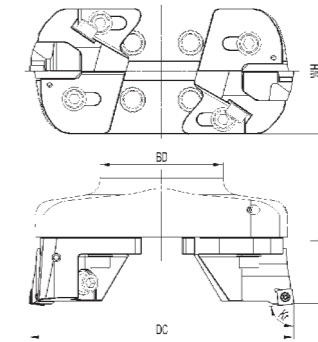

- Internal coolant supply
- SCMT SCGX SCMW
- The insert is for illustration only

技术参数 | Technical parameters

单位 | Unit: mm

订货号 Ordering code	镗削范围 Boring Range(DC)			尺寸 Dimension					刀片 Insert	夹紧方式 Clamping	接口 Coupling
	Min.	Max.	Adj.	L	BD	WH	Kr	KG			
GBT-BRB-160215-SC12-S-A40C	160	215	27.5	105	100	104	84	4.39	SCMT 120408	S	A40C
GBT-BRB-215270-SC12-S-A40C	215	270	27.5	105	100	104	84	5	SCMT 120408	S	A40C

备件 | Accessory

产品型号 Product ID	①	②	③	刀片螺钉扳手 Key(Insert)	刀垫螺钉扳手 Key(Shim)	锁紧螺钉扳手 Key(Screw)	调整螺钉扳手 Key(Adj.)
	桥架式刀座 Brigde Adaptor	滑块 Slide	刀夹 Cartridge				
GBT-BRB-160215-SC12-S-A40C	GBT-BPDB-A40C-160050	GBT-BPRB-SL-160	GBT-BPRB-CA-SC12-S	248.150.10-GBT	241.040.70-GBT	241.080.00-GBT	246.030.60-GBT
GBT-BRB-215270-SC12-S-A40C	GBT-BPDB-A40C-215050	GBT-BPRB-SL-160	GBT-BPRB-CA-SC12-S	248.150.10-GBT	241.040.70-GBT	241.080.00-GBT	246.030.60-GBT

可单独订购备件，按需询价。

关于BRB系列桥架式刀座请参阅C·44

关于BRB系列滑块请参阅C·46

The spare parts can be ordered separately. Please inquire on demand.

Please refer to C·44 for BRB series Brigde Adaptor

Please refer to C·46 for BRB series Sliding

BRB-SC-S系列

BRB-SC-S SERIES

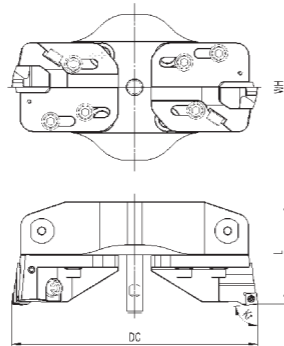
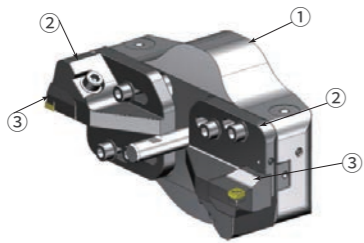

- 内冷却液供应
- SCMT SCGX SCMW
- 刀片仅做示意

- Internal coolant supply
- SCMT SCGX SCMW
- The insert is for illustration only

BRB-SC-S系列刀夹

BRB-SC-S SERIES CARTRIDGE

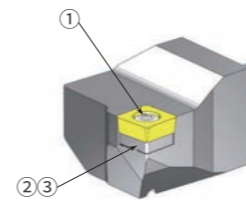

- SCMT SCGX SCMW
- 刀片仅做示意

- SCMT SCGX SCMW
- The insert is for illustration only

技术参数 | Technical parameters

单位 | Unit: mm

订货号 Ordering code	镗削范围 Boring Range(DC)			尺寸 Dimension					刀片 Insert	夹紧方式 Clamping	接口 Coupling
	Min.	Max.	Adj.	L	BD	WH	Kr	KG			
GBT-BRB-270350-SC12-S-A60C	270	350	40	115	-	140	84	7.8	SCMT 120408	S	A60C
GBT-BRB-350430-SC12-S-A60C	350	430	40	120	-	140	84	9.4	SCMT 120408	S	A60C
GBT-BRB-430510-SC12-S-A60C	430	510	40	125	-	140	84	11.1	SCMT 120408	S	A60C

备件 | Accessory

产品型号 Product ID	①	②	③				
	桥架式刀座 Brigde Adaptor	滑块 Slide	刀夹 Cartridge	刀片螺钉扳手 Key(Insert)	刀垫螺钉扳手 Key(Shim)	锁紧螺钉扳手 Key(Screw)	调整螺钉扳手 Key(Adj.)
GBT-BRB-270350-SC12-S-A60C	GBT-BPDB-A60C-270060	GBT-BPRB-SL-270	GBT-BPRB-CA-SC12-S	248.150.10-GBT	241.040.70-GBT	241.080.00-GBT	246.030.60-GBT
GBT-BRB-350430-SC12-S-A60C	GBT-BPDB-A60C-350065	GBT-BPRB-SL-270	GBT-BPRB-CA-SC12-S	248.150.10-GBT	241.040.70-GBT	241.080.00-GBT	246.030.60-GBT
GBT-BRB-430510-SC12-S-A60C	GBT-BPDB-A60C-430070	GBT-BPRB-SL-270	GBT-BPRB-CA-SC12-S	248.150.10-GBT	241.040.70-GBT	241.080.00-GBT	246.030.60-GBT

可单独订购备件，按需询价。

关于BRB系列桥架式刀座请参阅C·45

关于BRB系列滑块请参阅C·46

The spare parts can be ordered separately. Please inquire on demand.

Please refer to C·45 for BRB series Brigde Adaptor

Please refer to C·46 for BRB series Sliding

技术参数 | Technical parameters

单位 | Unit: mm

订货号 Ordering code	刀片 Insert	夹紧方式 Clamping
GBT-BPRB-CA-SC12-S	SC..120408	S

备件 | Accessory

单独订购 | Purchase Separately

产品型号 Product ID	①	②	③	
	刀片螺钉 Screw(Insert)	刀垫 Shim	刀垫螺钉 Screw(Shim)	刀片螺钉扳手 Key(Insert)
GBT-BPRB-CA-SC12-S	ILD 4014-GBT	322.420.02-GBT	512.090.03-GBT	248.150.10-GBT

可单独订购备件，按需询价。

The spare parts can be ordered separately. Please inquire on demand.

BRB-CN-D系列

BRB-CN-D SERIES

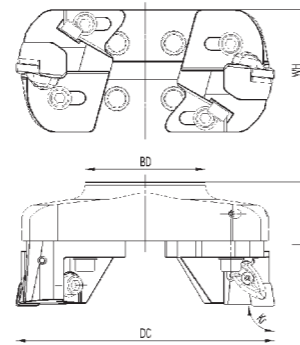
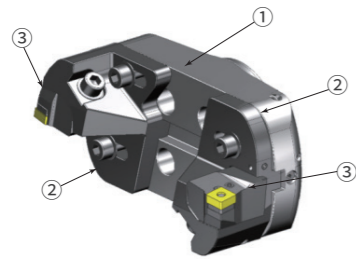

- 内冷却液供应
- CNMN CNMG CNMA CNGA
- 刀片仅做示意

- Internal coolant supply
- CNMN CNMG CNMA CNGA
- The insert is for illustration only

BRB-CN-D系列

BRB-CN-D SERIES

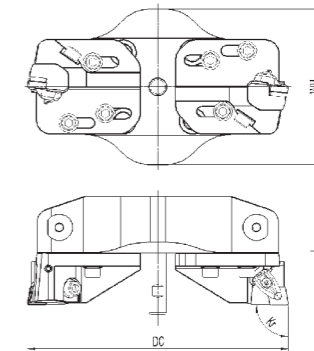
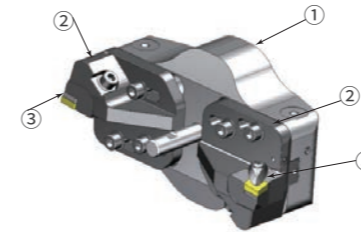

- 内冷却液供应
- CNMN CNMG CNMA CNGA
- 刀片仅做示意

- Internal coolant supply
- CNMN CNMG CNMA CNGA
- The insert is for illustration only

技术参数 | Technical parameters

单位 | Unit: mm

订货号 Ordering code	镗削范围 Boring Range(DC)			尺寸 Dimension					刀片 Insert	夹紧方式 Clamping	接口 Coupling
	Min.	Max.	Adj.	L	BD	WH	Kr	KG			
GBT-BRB-160215-CN12-D-A40C	160	215	27.5	105	100	104	90	4.39	CNMG 120408	D	A40C
GBT-BRB-215270-CN12-D-A40C	215	270	27.5	105	100	104	90	5	CNMG 120408	D	A40C
GBT-BRB-160215-CN16-D-A40C	160	215	27.5	105	100	104	90	4.39	CNMG 160612	D	A40C
GBT-BRB-215270-CN16-D-A40C	215	270	27.5	105	100	104	90	5	CNMG 160612	D	A40C
GBT-BRB-160215-CN19-D-A40C	160	215	27.5	105	100	104	90	4.39	CNMG 190612	D	A40C
GBT-BRB-215270-CN19-D-A40C	215	270	27.5	105	100	104	90	5	CNMG 190612	D	A40C

备件 | Accessory

产品型号 Product ID	①	②	③			
	桥架式刀座 Brigde Adaptor	滑块 Slide	刀夹 Cartridge	刀片螺钉扳手 Key(Insert)	锁紧螺钉扳手 Key(Screw)	调整螺钉扳手 Key(Adj.)
GBT-BRB-160215-CN12-D-A40C	GBT-BPDB-A40C-160050	GBT-BPRB-SL-160	GBT-BPRB-CA-CN12-D	248.150.10-GBT	241.080.00-GBT	246.030.60-GBT
GBT-BRB-215270-CN12-D-A40C	GBT-BPDB-A40C-215050	GBT-BPRB-SL-160	GBT-BPRB-CA-CN12-D	248.150.10-GBT	241.080.00-GBT	246.030.60-GBT
GBT-BRB-160215-CN16-D-A40C	GBT-BPDB-A40C-160050	GBT-BPRB-SL-160	GBT-BPRB-CA-CN16-D	248.200.10-GBT	241.080.00-GBT	246.030.60-GBT
GBT-BRB-215270-CN16-D-A40C	GBT-BPDB-A40C-215050	GBT-BPRB-SL-160	GBT-BPRB-CA-CN16-D	248.200.10-GBT	241.080.00-GBT	246.030.60-GBT
GBT-BRB-160215-CN19-D-A40C	GBT-BPDB-A40C-160050	GBT-BPRB-SL-160	GBT-BPRB-CA-CN19-D	248.200.10-GBT	241.080.00-GBT	246.030.60-GBT
GBT-BRB-215270-CN19-D-A40C	GBT-BPDB-A40C-215050	GBT-BPRB-SL-160	GBT-BPRB-CA-CN19-D	248.200.10-GBT	241.080.00-GBT	246.030.60-GBT

可单独订购备件，按需询价。

The spare parts can be ordered separately. Please inquire on demand.

关于BRB系列桥架式刀座请参阅C·44

Please refer to C·44 for BRB series Brigde Adaptor

关于BRB系列滑块请参阅C·46

Please refer to C·46 for BRB series Sliding

技术参数 | Technical parameters

单位 | Unit: mm



订货号 Ordering code	镗削范围 Boring Range(DC)			尺寸 Dimension					刀片 Insert	夹紧方式 Clamping	接口 Coupling
	Min.	Max.	Adj.	L	BD	WH	Kr	KG			
GBT-BRB-270350-CN12-D-A60C	270	350	40	115	-	140	90	7.8	CNMG 120408	D	A60C
GBT-BRB-350430-CN12-D-A60C	350	430	40	120	-	140	90	9.4	CNMG 120408	D	A60C
GBT-BRB-430510-CN12-D-A60C	430	510	40	125	-	140	90	11.1	CNMG 120408	D	A60C
GBT-BRB-270350-CN16-D-A60C	270	350	40	115	-	140	90	7.8	CNMG 160612	D	A60C
GBT-BRB-350430-CN16-D-A60C	350	430	40	120	-	140	90	9.4	CNMG 160612	D	A60C
GBT-BRB-430510-CN16-D-A60C	430	510	40	125	-	140	90	11.1	CNMG 160612	D	A60C
GBT-BRB-270350-CN19-D-A60C	270	350	40	115	-	140	90	7.8	CNMG 190612	D	A60C
GBT-BRB-350430-CN19-D-A60C	350	430	40	120	-	140	90	9.4	CNMG 190612	D	A60C
GBT-BRB-430510-CN19-D-A60C	430	510	40	125	-	140	90	11.1	CNMG 190612	D	A60C

转下页 see next page →

BRB-CN-D系列

BRB-CN-D SERIES

备件 | Accessory

产品型号 Product ID	①	②	③			
	桥架式刀座 Brigde Adaptor	滑块 Slide	刀夹 Cartridge	刀片螺钉扳手 Key(Insert)	锁紧螺钉扳手 Key(Screw)	调整螺钉扳手 Key(Adj.)
GBT-BRB-270350-CN12-D-A60C	GBT-BPDB-A60C-270060	GBT-BPRB-SL-270	GBT-BPRB-CA-CN12-D	248.150.10-GBT	241.080.00-GBT	246.030.60-GBT
GBT-BRB-350430-CN12-D-A60C	GBT-BPDB-A60C-350065	GBT-BPRB-SL-270	GBT-BPRB-CA-CN12-D	248.150.10-GBT	241.080.00-GBT	246.030.60-GBT
GBT-BRB-430510-CN12-D-A60C	GBT-BPDB-A60C-430070	GBT-BPRB-SL-270	GBT-BPRB-CA-CN12-D	248.150.10-GBT	241.080.00-GBT	246.030.60-GBT
GBT-BRB-270350-CN16-D-A60C	GBT-BPDB-A60C-270060	GBT-BPRB-SL-270	GBT-BPRB-CA-CN16-D	248.200.10-GBT	241.080.00-GBT	246.030.60-GBT
GBT-BRB-350430-CN16-D-A60C	GBT-BPDB-A60C-350065	GBT-BPRB-SL-270	GBT-BPRB-CA-CN16-D	248.200.10-GBT	241.080.00-GBT	246.030.60-GBT
GBT-BRB-430510-CN16-D-A60C	GBT-BPDB-A60C-430070	GBT-BPRB-SL-270	GBT-BPRB-CA-CN16-D	248.200.10-GBT	241.080.00-GBT	246.030.60-GBT
GBT-BRB-270350-CN19-D-A60C	GBT-BPDB-A60C-270060	GBT-BPRB-SL-270	GBT-BPRB-CA-CN19-D	248.200.10-GBT	241.080.00-GBT	246.030.60-GBT
GBT-BRB-350430-CN19-D-A60C	GBT-BPDB-A60C-350065	GBT-BPRB-SL-270	GBT-BPRB-CA-CN19-D	248.200.10-GBT	241.080.00-GBT	246.030.60-GBT
GBT-BRB-430510-CN19-D-A60C	GBT-BPDB-A60C-430070	GBT-BPRB-SL-270	GBT-BPRB-CA-CN19-D	248.200.10-GBT	241.080.00-GBT	246.030.60-GBT

可单独订购备件，按需询价。

关于BRB系列桥架式刀座请参阅C·45

关于BRB系列滑块请参阅C·46

The spare parts can be ordered separately. Please inquire on demand.

Please refer to C·45 for BRB series Brigde Adaptor

Please refer to C·46 for BRB series Sliding

BRB-CN-D系列刀夹

BRB-CN-D SERIES CARTRIDGE

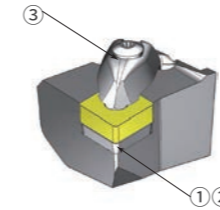

● CNMN CNMG CNMA CNGA

● 刀片仅做示意

● CNMN CNMG CNMA CNGA

● The insert is for illustration only

技术参数 | Technical parameters

单位 | Unit: mm

订货号 Ordering code	刀片 Insert	夹紧方式 Clamping
GBT-BPRB-CA-CN12-D	CN..120408	D
GBT-BPRB-CA-CN16-D	CN..160612	D
GBT-BPRB-CA-CN19-D	CN..190612	D

产品型号 Product ID	备件 Accessory			单独订购 Purchase Separately
	① 刀垫 Shim	② 刀垫螺钉 Screw(Shim)	③ 压板组件 Clamp Set	 刀片螺钉扳手 Key(Insert)
GBT-BPRB-CA-CN12-D	322.236.03-GBT	SFS 4085-GBT	412.028.21-GBT	248.150.10-GBT
GBT-BPRB-CA-CN16-D	322.234.03-GBT	SFS 5011-GBT	412.028.31-GBT	248.200.10-GBT
GBT-BPRB-CA-CN19-D	322.236.01-GBT	SFS 5011-GBT	412.028.41-GBT	248.200.10-GBT

可单独订购备件，按需询价。

The spare parts can be ordered separately. Please inquire on demand.

BRB-SN-D系列

BRB-SN-D SERIES

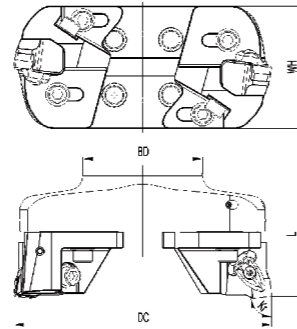
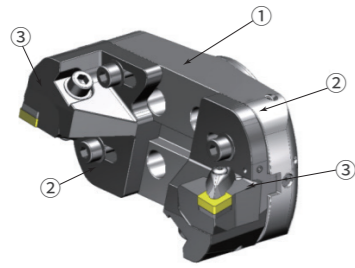

- 内冷却液供应
- SNMM SNMG SNMA SNGA
- 刀片仅做示意

- Internal coolant supply
- SNMM SNMG SNMA SNGA
- The insert is for illustration only

BRB-SN-D系列

BRB-SN-D SERIES

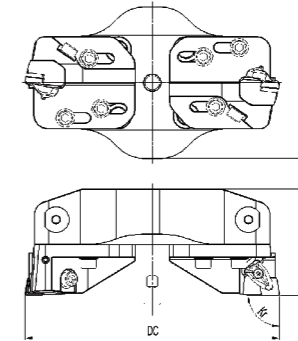
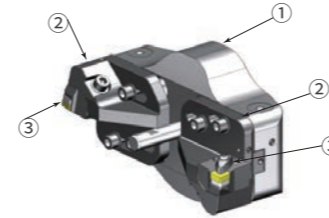

- 内冷却液供应
- SNMM SNMG SNMA SNGA
- 刀片仅做示意

- Internal coolant supply
- SNMM SNMG SNMA SNGA
- The insert is for illustration only

技术参数 | Technical parameters

单位 | Unit: mm

订货号 Ordering code	镗削范围 Boring Range(DC)			尺寸 Dimension					刀片 Insert	夹紧方式 Clamping	接口 Coupling
	Min.	Max.	Adj.	L	BD	WH	Kr	KG			
GBT-BBRB-160215-SN12-D-A40C	160	215	27.5	105	100	104	84	4.39	SNMG 120408	D	A40C
GBT-BBRB-215270-SN12-D-A40C	215	270	27.5	105	100	104	84	5	SNMG 120408	D	A40C
GBT-BBRB-160215-SN15-D-A40C	160	215	27.5	105	100	104	84	4.39	SNMG 150612	D	A40C
GBT-BBRB-215270-SN15-D-A40C	215	270	27.5	105	100	104	84	5	SNMG 150612	D	A40C

备件 | Accessory

产品型号 Product ID	①	②	③			
	桥架式刀座 Brigde Adaptor	滑块 Slide	刀夹 Cartridge	刀片螺钉扳手 Key(Insert)	锁紧螺钉扳手 Key(Screw)	调整螺钉扳手 Key(Adj.)
GBT-BRB-160215-SN12-D-A40C	GBT-BPDB-A40C-160050	GBT-BPRB-SL-160	GBT-BPRB-CA-SN12-D	248.150.10-GBT	241.080.00-GBT	246.030.60-GBT
GBT-BRB-215270-SN12-D-A40C	GBT-BPDB-A40C-215050	GBT-BPRB-SL-160	GBT-BPRB-CA-SN12-D	248.150.10-GBT	241.080.00-GBT	246.030.60-GBT
GBT-BRB-160215-SN15-D-A40C	GBT-BPDB-A40C-160050	GBT-BPRB-SL-160	GBT-BPRB-CA-SN15-D	248.200.10-GBT	241.080.00-GBT	246.030.60-GBT
GBT-BRB-215270-SN15-D-A40C	GBT-BPDB-A40C-215050	GBT-BPRB-SL-160	GBT-BPRB-CA-SN15-D	248.200.10-GBT	241.080.00-GBT	246.030.60-GBT

可单独订购备件，按需询价。
关于BRB系列桥架式刀座请参阅C·44
关于BRB系列滑块请参阅C·46

The spare parts can be ordered separately. Please inquire on demand.
Please refer to C·44 for BRB series Brigde Adaptor
Please refer to C·46 for BRB series Sliding

技术参数 | Technical parameters

单位 | Unit: mm

订货号 Ordering code	镗削范围 Boring Range(DC)			尺寸 Dimension					刀片 Insert	夹紧方式 Clamping	接口 Coupling
	Min.	Max.	Adj.	L	BD	WH	Kr	KG			
GBT-BRB-270350-SN12-D-A60C	270	350	40	115	-	140	84	7.8	SNMG 120408	D	A60C
GBT-BRB-350430-SN12-D-A60C	350	430	40	120	-	140	84	9.4	SNMG 120408	D	A60C
GBT-BRB-430510-SN12-D-A60C	430	510	40	125	-	140	84	11.1	SNMG 120408	D	A60C
GBT-BRB-270350-SN15-D-A60C	270	350	40	115	-	140	84	7.8	SNMG 150612	D	A60C
GBT-BRB-350430-SN15-D-A60C	350	430	40	120	-	140	84	9.4	SNMG 150612	D	A60C
GBT-BRB-430510-SN15-D-A60C	430	510	40	125	-	140	84	11.1	SNMG 150612	D	A60C

备件 | Accessory

产品型号 Product ID	①	②	③			
	桥架式刀座 Brigde Adaptor	滑块 Slide	刀夹 Cartridge	刀片螺钉扳手 Key(Insert)	锁紧螺钉扳手 Key(Screw)	调整螺钉扳手 Key(Adj.)
GBT-BRB-270350-SN12-D-A60C	GBT-BPDB-A60C-270060	GBT-BPRB-SL-270	GBT-BPRB-CA-SN12-D	248.150.10-GBT	241.080.00-GBT	246.030.60-GBT
GBT-BRB-350430-SN12-D-A60C	GBT-BPDB-A60C-350065	GBT-BPRB-SL-270	GBT-BPRB-CA-SN12-D	248.150.10-GBT	241.080.00-GBT	246.030.60-GBT
GBT-BRB-430510-SN12-D-A60C	GBT-BPDB-A60C-430070	GBT-BPRB-SL-270	GBT-BPRB-CA-SN12-D	248.150.10-GBT	241.080.00-GBT	246.030.60-GBT
GBT-BRB-270350-SN15-D-A60C	GBT-BPDB-A60C-270060	GBT-BPRB-SL-270	GBT-BPRB-CA-SN15-D	248.200.10-GBT	241.080.00-GBT	246.030.60-GBT
GBT-BRB-350430-SN15-D-A60C	GBT-BPDB-A60C-350065	GBT-BPRB-SL-270	GBT-BPRB-CA-SN15-D	248.200.10-GBT	241.080.00-GBT	246.030.60-GBT
GBT-BRB-430510-SN15-D-A60C	GBT-BPDB-A60C-430070	GBT-BPRB-SL-270	GBT-BPRB-CA-SN15-D	248.200.10-GBT	241.080.00-GBT	246.030.60-GBT

可单独订购备件，按需询价。
关于BRB系列桥架式刀座请参阅C·45
关于BRB系列滑块请参阅C·46

The spare parts can be ordered separately. Please inquire on demand.
Please refer to C·45 for BRB series Brigde Adaptor
Please refer to C·46 for BRB series Sliding

BRB-SN-D系列刀夹

BRB-SN-D SERIES CARTRIDGE

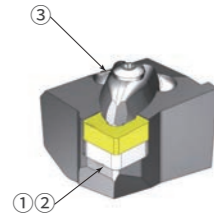

- SNMM SNMG SNMA SNGA
- 刀片仅做示意

- SNMM SNMG SNMA SNGA
- The insert is for illustration only

技术参数 | Technical parameters

单位 | Unit: mm

订货号 Ordering code	刀片 Insert	夹紧方式 Clamping
GBT-BPRB-CA-SN12-D	SN..120408	D
GBT-BPRB-CA-SN15-D	SN..150612	D

产品型号 Product ID	备件 Accessory			单独订购 Purchase Separately
	① 刀垫 Shim	② 刀垫螺钉 Screw(Shim)	③ 压板组件 Clamp Set	 刀片螺钉扳手 Key(Insert)
GBT-BPRB-CA-SN12-D	322.426.02-GBT	SFS 4085-GBT	412.028.21-GBT	248.150.10-GBT
GBT-BPRB-CA-SN15-D	322.425.03-GBT	SFS 5011-GBT	412.028.31-GBT	248.200.10-GBT

可单独订购备件，按需询价。

The spare parts can be ordered separately. Please inquire on demand.

BRB-CN-P系列

BRB-CN-P SERIES

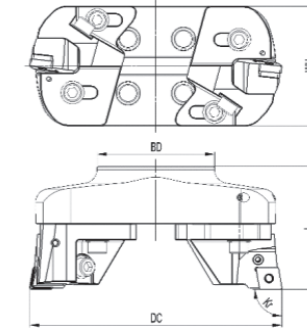

- 内冷却液供应
- CNMM CNMG CNMA CNGA
- 刀片仅做示意

- Internal coolant supply
- CNMM CNMG CNMA CNGA
- The insert is for illustration only

技术参数 | Technical parameters

单位 | Unit: mm

订货号 Ordering code	镗削范围 Boring Range(DC)			尺寸 Dimension					刀片 Insert	夹紧方式 Clamping	接口 Coupling
	Min.	Max.	Adj.	L	BD	WH	Kr	KG			
GBT-BRB-160215-CN12-P-A40C	160	215	27.5	105	100	104	90	4.39	CNMG120408	P	A40C
GBT-BRB-215270-CN12-P-A40C	215	270	27.5	105	100	104	90	5	CNMG120408	P	A40C
GBT-BRB-160215-CN16-P-A40C	160	215	27.5	105	100	104	90	4.39	CNMG160612	P	A40C
GBT-BRB-215270-CN16-P-A40C	215	270	27.5	105	100	104	90	5	CNMG160612	P	A40C
GBT-BRB-160215-CN19-P-A40C	160	215	27.5	107	100	104	90	4.39	CNMG190612	P	A40C
GBT-BRB-215270-CN19-P-A40C	215	270	27.5	107	100	104	90	5	CNMG190612	P	A40C

备件 | Accessory

产品型号 Product ID	①	②	③			
	桥架式刀座 Brigde Adaptor	滑块 Slide	刀夹 Cartridge	刀片螺钉扳手 Key(Insert)	锁紧螺钉扳手 Key(Screw)	调整螺钉扳手 Key(Adj.)
GBT-BRB-160215-CN12-P-A40C	GBT-BPDB-A40C-160050	GBT-BPRB-SL-160	GBT-BPRB-CA-CN12-P	241.030.63-GBT	241.080.00-GBT	246.030.60-GBT
GBT-BRB-215270-CN12-P-A40C	GBT-BPDB-A40C-215050	GBT-BPRB-SL-160	GBT-BPRB-CA-CN12-P	241.030.63-GBT	241.080.00-GBT	246.030.60-GBT
GBT-BRB-160215-CN16-P-A40C	GBT-BPDB-A40C-160050	GBT-BPRB-SL-160	GBT-BPRB-CA-CN16-P	241.030.63-GBT	241.080.00-GBT	246.030.60-GBT
GBT-BRB-215270-CN16-P-A40C	GBT-BPDB-A40C-215050	GBT-BPRB-SL-160	GBT-BPRB-CA-CN16-P	241.030.63-GBT	241.080.00-GBT	246.030.60-GBT
GBT-BRB-160215-CN19-P-A40C	GBT-BPDB-A40C-160050	GBT-BPRB-SL-160	GBT-BPRB-CA-CN19-P	241.040.70-GBT	241.080.00-GBT	246.030.60-GBT
GBT-BRB-215270-CN19-P-A40C	GBT-BPDB-A40C-215050	GBT-BPRB-SL-160	GBT-BPRB-CA-CN19-P	241.040.70-GBT	241.080.00-GBT	246.030.60-GBT

可单独订购备件，按需询价。

关于BRB系列桥架式刀座请参阅C·44

关于BRB系列滑块请参阅C·46

The spare parts can be ordered separately. Please inquire on demand.

Please refer to C·44 for BRB series Brigde Adaptor

Please refer to C·46 for BRB series Sliding

BRB-CN-P系列

BRB-CN-P SERIES

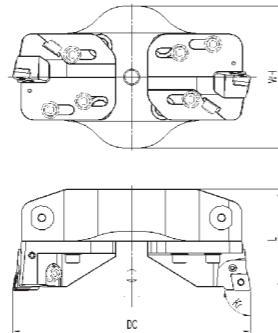
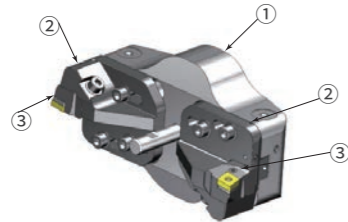

- 内冷却液供应
- CNMM CNMG CNMA CNGA
- 刀片仅做示意

- Internal coolant supply
- CNMM CNMG CNMA CNGA
- The insert is for illustration only

技术参数 | Technical parameters

单位 | Unit: mm



订货号 Ordering code	镗削范围 Boring Range(DC)			尺寸 Dimension					刀片 Insert	夹紧方式 Clamping	接口 Coupling
	Min.	Max.	Adj.	L	BD	WH	Kr	KG			
GBT-BRB-270350-CN12-P-A60C	270	350	40	115	-	140	90	7.8	CNMG120408	P	A60C
GBT-BRB-350430-CN12-P-A60C	350	430	40	120	-	140	90	9.4	CNMG120408	P	A60C
GBT-BRB-430510-CN12-P-A60C	430	510	40	125	-	140	90	11.1	CNMG120408	P	A60C
GBT-BRB-270350-CN16-P-A60C	270	350	40	115	-	140	90	7.8	CNMG160612	P	A60C
GBT-BRB-350430-CN16-P-A60C	350	430	40	120	-	140	90	9.4	CNMG160612	P	A60C
GBT-BRB-430510-CN16-P-A60C	430	510	40	125	-	140	90	11.1	CNMG160612	P	A60C
GBT-BRB-270350-CN19-P-A60C	270	350	40	117	-	140	90	7.8	CNMG190612	P	A60C
GBT-BRB-350430-CN19-P-A60C	350	430	40	122	-	140	90	9.4	CNMG190612	P	A60C
GBT-BRB-430510-CN19-P-A60C	430	510	40	127	-	140	90	11.1	CNMG190612	P	A60C

转下页 see next page →

BRB-CN-P系列

BRB-CN-P SERIES

备件 | Accessory

产品型号 Product ID	①	②	③			
	桥架式刀座 Brigde Adaptor	滑块 Slide	刀夹 Cartridge	刀片螺钉扳手 Key(Insert)	锁紧螺钉扳手 Key(Screw)	调整螺钉扳手 Key(Adj.)
GBT-BRB-270350-CN12-P-A60C	GBT-BPDB-A60C-270060	GBT-BPRB-SL-270	GBT-BPRB-CA-CN12-P	-241.030.63-GBT	241.080.00-GBT	246.030.60-GBT
GBT-BRB-350430-CN12-P-A60C	GBT-BPDB-A60C-350065	GBT-BPRB-SL-270	GBT-BPRB-CA-CN12-P	241.030.63-GBT	241.080.00-GBT	246.030.60-GBT
GBT-BRB-430510-CN12-P-A60C	GBT-BPDB-A60C-430070	GBT-BPRB-SL-270	GBT-BPRB-CA-CN12-P	241.030.63-GBT	241.080.00-GBT	246.030.60-GBT
GBT-BRB-270350-CN16-P-A60C	GBT-BPDB-A60C-270060	GBT-BPRB-SL-270	GBT-BPRB-CA-CN16-P	241.030.63-GBT	241.080.00-GBT	246.030.60-GBT
GBT-BRB-350430-CN16-P-A60C	GBT-BPDB-A60C-350065	GBT-BPRB-SL-270	GBT-BPRB-CA-CN16-P	241.030.63-GBT	241.080.00-GBT	246.030.60-GBT
GBT-BRB-430510-CN16-P-A60C	GBT-BPDB-A60C-430070	GBT-BPRB-SL-270	GBT-BPRB-CA-CN16-P	241.030.63-GBT	241.080.00-GBT	246.030.60-GBT
GBT-BRB-270350-CN19-P-A60C	GBT-BPDB-A60C-270060	GBT-BPRB-SL-270	GBT-BPRB-CA-CN19-P	241.040.70-GBT	241.080.00-GBT	246.030.60-GBT
GBT-BRB-350430-CN19-P-A60C	GBT-BPDB-A60C-350065	GBT-BPRB-SL-270	GBT-BPRB-CA-CN19-P	241.040.70-GBT	241.080.00-GBT	246.030.60-GBT
GBT-BRB-430510-CN19-P-A60C	GBT-BPDB-A60C-430070	GBT-BPRB-SL-270	GBT-BPRB-CA-CN19-P	241.040.70-GBT	241.080.00-GBT	246.030.60-GBT

可单独订购备件，按需询价。
关于BRB系列桥架式刀座请参阅C·45
关于BRB系列滑块请参阅C·46

The spare parts can be ordered separately. Please inquire on demand.
Please refer to C·45 for BRB series Brigde Adaptor
Please refer to C·46 for BRB series Sliding

BRB-CN-P系列刀夹

BRB-CN-D SERIES CARTRIDGE

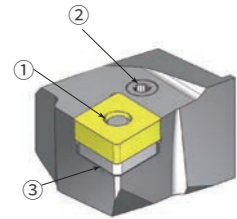

- CNMM CNMG CNMA CNGA
- 刀片仅做示意

- CNMM CNMG CNMA CNGA
- The insert is for illustration only

BRB-SN-P系列

BRB-SN-P SERIES

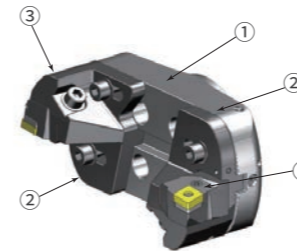

- 内冷却液供应
- SNMM SNMG SNMA SNGA
- 刀片仅做示意

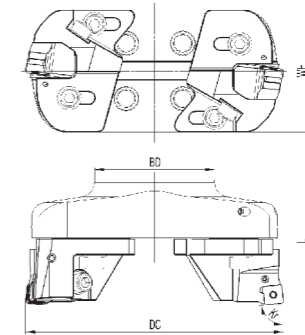

- Internal coolant supply
- SNMM SNMG SNMA SNGA
- The insert is for illustration only

技术参数 | Technical parameters

单位 | Unit: mm

订货号 Ordering code	刀片 Insert	夹紧方式 Clamping
GBT-BPRB-CA-CN12-P	CN..120408	P
GBT-BPRB-CA-CN16-P	CN..160612	P
GBT-BPRB-CA-CN19-P	CN..190612	P

技术参数 | Technical parameters

单位 | Unit: mm

订货号 Ordering code	镗削范围 Boring Range(DC)			尺寸 Dimension					刀片 Insert	夹紧方式 Clamping	接口 Coupling
	Min.	Max.	Adj.	L	BD	WH	Kr	KG			
GBT-BRB-160215-SN12-P-A40C	160	215	27.5	105	100	104	84	4.39	SNMG120408	P	A40C
GBT-BRB-215270-SN12-P-A40C	215	270	27.5	105	100	104	84	5	SNMG120408	P	A40C
GBT-BRB-160215-SN15-P-A40C	160	215	27.5	105	100	104	84	4.39	SNMG150612	P	A40C
GBT-BRB-215270-SN15-P-A40C	215	270	27.5	105	100	104	84	5	SNMG150612	P	A40C

产品型号 Product ID	备件 Accessory			单独订购 Purchase Separately
	① 杠杆 Lever	② 螺钉 Screw	③ 刀垫 Shim	扳手 Key
GBT-BPRB-CA-CN12-P	413.438.41-GBT	414.438.21-GBT	322.318.50-GBT	241.030.63-GBT
GBT-BPRB-CA-CN16-P	413.838.40-GBT	414.838.31-GBT	322.318.52-GBT	241.030.63-GBT
GBT-BPRB-CA-CN19-P	413.438.42-GBT	414.438.22-GBT	322.318.51-GBT	241.040.70-GBT

可单独订购备件，按需询价。

The spare parts can be ordered separately. Please inquire on demand.

备件 | Accessory

产品型号 Product ID	①	②	③	刀片螺钉扳手 Key(Insert)	锁紧螺钉扳手 Key(Screw)	调整螺钉扳手 Key(Adj.)
	桥架式刀座 Brigde Adaptor	滑块 Slide	刀夹 Cartridge			
GBT-BRB-160215-SN12-P-A40C	GBT-BPDB-A40C-160050	GBT-BPRB-SL-160	GBT-BPRB-CA-SN12-P	241.030.63-GBT	241.080.00-GBT	246.030.60-GBT
GBT-BRB-215270-SN12-P-A40C	GBT-BPDB-A40C-215050	GBT-BPRB-SL-160	GBT-BPRB-CA-SN12-P	241.030.63-GBT	241.080.00-GBT	246.030.60-GBT
GBT-BRB-160215-SN15-P-A40C	GBT-BPDB-A40C-160050	GBT-BPRB-SL-160	GBT-BPRB-CA-SN15-P	241.030.63-GBT	241.080.00-GBT	246.030.60-GBT
GBT-BRB-215270-SN15-P-A40C	GBT-BPDB-A40C-215050	GBT-BPRB-SL-160	GBT-BPRB-CA-SN15-P	241.030.63-GBT	241.080.00-GBT	246.030.60-GBT

可单独订购备件，按需询价。

关于BRB系列桥架式刀座请参阅C·44
关于BRB系列滑块请参阅C·46

The spare parts can be ordered separately. Please inquire on demand.

Please refer to C·44 for BRB series Brigde Adaptor
Please refer to C·46 for BRB series Sliding

BRB-SN-P系列

BRB-SN-P SERIES

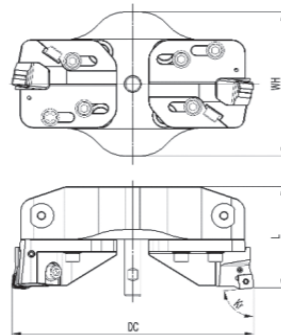
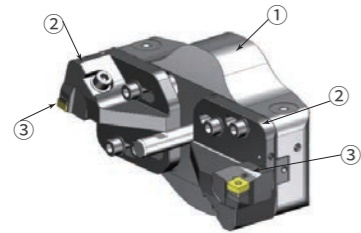

- 内冷却液供应
- SNMM SNMG SNMA SNGA
- 刀片仅做示意

- Internal coolant supply
- SNMM SNMG SNMA SNGA
- The insert is for illustration only

技术参数 | Technical parameters

单位 | Unit: mm

订货号 Ordering code	镗削范围 Boring Range(DC)			尺寸 Dimension					刀片 Insert	夹紧方式 Clamping	接口 Coupling
	Min.	Max.	Adj.	L	BD	WH	Kr	KG			
GBT-BRB-270350-SN12-P-A60C	270	350	40	115	-	140	84	7.8	SNMG120408	P	A60C
GBT-BRB-350430-SN12-P-A60C	350	430	40	120	-	140	84	9.4	SNMG120408	P	A60C
GBT-BRB-430510-SN12-P-A60C	430	510	40	125	-	140	84	11.1	SNMG120408	P	A60C
GBT-BRB-270350-SN15-P-A60C	270	350	40	115	-	140	84	7.8	SNMG150612	P	A60C
GBT-BRB-350430-SN15-P-A60C	350	430	40	120	-	140	84	9.4	SNMG150612	P	A60C
GBT-BRB-430510-SN15-P-A60C	430	510	40	125	-	140	84	11.1	SNMG150612	P	A60C

备件 | Accessory

产品型号 Product ID	①	②	③			
	桥架式刀座 Brigde Adaptor	滑块 Slide	刀夹 Cartridge	刀片螺钉扳手 Key(Insert)	锁紧螺钉扳手 Key(Screw)	调整螺钉扳手 Key(Adj.)
GBT-BRB-270350-SN12-P-A60C	GBT-BPDB-A60C-270060	GBT-BPRB-SL-270	GBT-BPRB-CA-SN12-P	241.030.63-GBT	241.080.00-GBT	246.030.60-GBT
GBT-BRB-350430-SN12-P-A60C	GBT-BPDB-A60C-350065	GBT-BPRB-SL-270	GBT-BPRB-CA-SN12-P	241.030.63-GBT	241.080.00-GBT	246.030.60-GBT
GBT-BRB-430510-SN12-P-A60C	GBT-BPDB-A60C-430070	GBT-BPRB-SL-270	GBT-BPRB-CA-SN12-P	241.030.63-GBT	241.080.00-GBT	246.030.60-GBT
GBT-BRB-270350-SN15-P-A60C	GBT-BPDB-A60C-270060	GBT-BPRB-SL-270	GBT-BPRB-CA-SN15-P	241.030.63-GBT	241.080.00-GBT	246.030.60-GBT
GBT-BRB-350430-SN15-P-A60C	GBT-BPDB-A60C-350065	GBT-BPRB-SL-270	GBT-BPRB-CA-SN15-P	241.030.63-GBT	241.080.00-GBT	246.030.60-GBT
GBT-BRB-430510-SN15-P-A60C	GBT-BPDB-A60C-430070	GBT-BPRB-SL-270	GBT-BPRB-CA-SN15-P	241.030.63-GBT	241.080.00-GBT	246.030.60-GBT

可单独订购备件，按需询价。

关于BRB系列桥架式刀座请参阅C·45
关于BRB系列滑块请参阅C·46

The spare parts can be ordered separately. Please inquire on demand.

Please refer to C·45 for BRB series Brigde Adaptor
Please refer to C·46 for BRB series Sliding

BRB-SN-P系列刀夹

BRA-SN-P SERIES CARTRIDGE

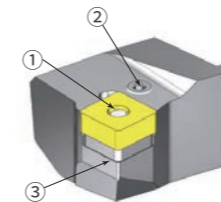

- SNMM SNMG SNMA SNGA
- 刀片仅做示意

- SNMM SNMG SNMA SNGA
- The insert is for illustration only

技术参数 | Technical parameters

单位 | Unit: mm

订货号 Ordering code	刀片 Insert	夹紧方式 Clamping
GBT-BPRB-CA-SN12-P	SN..120408	P
GBT-BPRB-CA-SN15-P	SN..150612	P

备件 | Accessory

单独订购 | Purchase Separately

产品型号 Product ID	①	②	③	
	杠杆 Lever	螺钉 Screw	刀垫 Shim	扳手 Key
GBT-BPRB-CA-SN12-P	413.438.41-GBT	414.438.21-GBT	322.438.51-GBT	241.030.63-GBT
GBT-BPRB-CA-SN15-P	413.838.40-GBT	414.838.31-GBT	322.438.57-GBT	241.030.63-GBT

可单独订购备件，按需询价。

The spare parts can be ordered separately. Please inquire on demand.

BRB系列桥架式刀座

BRB SERIES BRIGDE ADAPTOR

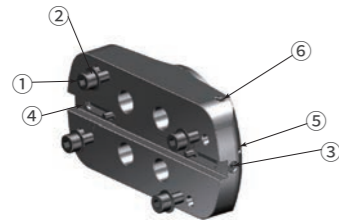

技术参数 | Technical parameters

单位 | Unit: mm

订货号 Ordering code	直径范围 Fitting Range	接口 Coupling
GBT-BPDB-A40C-160050	160-215	A40C
GBT-BPDB-A40C-215050	215-270	A40C

产品型号 Product ID	备件 Accessary						单独订购 Purchase Separately	
	① 锁紧螺钉 Screw(Lock)	② 蝶形弹簧垫圈 Shim	③ 调整螺钉 Screw(Adj.)	④ 挡销 Pin(Stop)	⑤ 堵丝 Nozzle	⑥ 堵丝 Nozzle	锁紧螺钉扳手 Key(Screw)	调整螺钉扳手 Key(Adj.)
GBT-BPDB-A40C-160050	113.100.30-GBT	136.100.11-GBT	519.091.01-GBT	212.230.207-GBT	251.050.05-GBT	-	241.080.00-GBT	246.030.60-GBT
GBT-BPDB-A40C-215050	113.100.30-GBT	136.100.11-GBT	519.091.01-GBT	212.230.207-GBT	251.050.05-GBT	251.060.06-GBT	241.080.00-GBT	246.030.60-GBT

可单独订购备件，按需询价。

The spare parts can be ordered separately. Please inquire on demand.

BRB系列桥架式刀座

BRB SERIES BRIGDE ADAPTOR

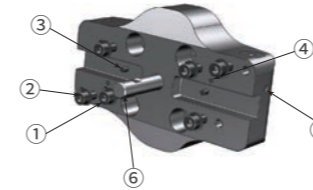

技术参数 | Technical parameters

单位 | Unit: mm

订货号 Ordering code	直径范围 Fitting Range	接口 Coupling
GBT-BPDB-A60C-270060	270-350	A60C
GBT-BPDB-A60C-350065	350-430	A60C
GBT-BPDB-A60C-430070	430-510	A60C

产品型号 Product ID	备件 Accessary						单独订购 Purchase Separately
	① 锁紧螺钉 Screw(Lock)	② 蝶形弹簧垫圈 Shim	③ 圆柱销 Pin	④ 堵丝 Nozzle	⑤ 堵丝 Nozzle	⑥ 测量销 Pin(Measuring)	锁紧螺钉扳手 Key(Screw)
GBT-BPDB-A60C-270060	113.100.30-GBT	136.100.11-GBT	171.060.16-GBT	251.050.05-GBT	251.060.06-GBT	MP-1875-GBT	241.080.00-GBT
GBT-BPDB-A60C-350065	113.100.30-GBT	136.100.11-GBT	171.060.16-GBT	251.050.05-GBT	251.080.08-GBT	MP-1875-GBT	241.080.00-GBT
GBT-BPDB-A60C-430070	113.100.30-GBT	136.100.11-GBT	171.060.16-GBT	251.050.05-GBT	251.080.08-GBT	MP-1875-GBT	241.080.00-GBT

可单独订购备件，按需询价。

The spare parts can be ordered separately. Please inquire on demand.

BRB系列滑块

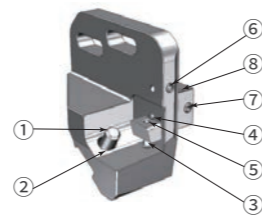
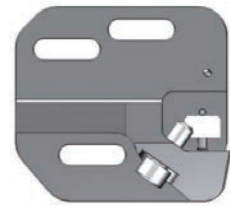

BRB SERIES SLIDE



技术参数 | Technical parameters

单位 | Unit: mm

订货号 Ordering code	直径范围 Fitting Range
GBT-BPRB-SL-160	160-270
GBT-BPRB-SL-270	270-510

产品型号 Product ID	备件 Accessory								单独订购 Purchase Separately	
	① 锁紧螺钉 Screw(Lock)	② 蝶形弹簧垫圈 Shim	③ 双头螺丝 Studs	④ 挡销 Pin(Stop)	⑤ 楔块 Wedge	⑥ 堵丝 Nozzle	⑦ 调整螺钉 Screw(Adj.)	⑧ 堵丝 Nozzle	 锁紧螺钉扳手 Key(Screw)	 调整螺钉扳手 Key(Adj.)
GBT-BPRB-SL-160	113.100.25-GBT	136.100.11-GBT	115.060.25-GBT	212.230.207-GBT	288.060.01-GBT	251.050.05-GBT	-	-	241.080.00-GBT	246.030.60-GBT
GBT-BPRB-SL-270	113.100.25-GBT	136.100.11-GBT	115.060.25-GBT	212.230.207-GBT	288.060.01-GBT	251.050.05-GBT	214.020.368-GBT	254.030.10-GBT	241.080.00-GBT	246.030.60-GBT

可单独订购备件，按需询价。

The spare parts can be ordered separately. Please inquire on demand.

精镗刀BFA系列 | BFA SERIES



- 适用于Φ20-Φ160mm的孔径精加工；
- 加工孔径公差可达IT6级；
- 直径调节精度0.002mm；

- Apply to Φ 20- Φ 160mm aperture finishing;
- Machining aperture tolerance can reach IT6;
- Diameter adjustment accuracy: 0.002mm;

BFA-TC系列

BFA-TC SERIES

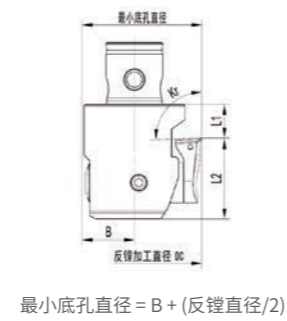
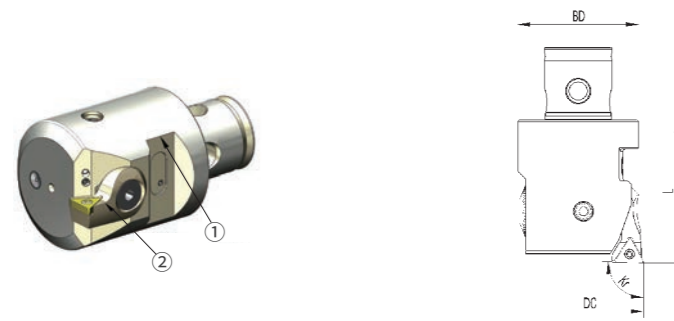

最小底孔直径 = B + (反镗直径/2)

- 内冷却液供应
- TCMT TCMX TCGT TCGX TCEX TCMW
- 刀片仅做示意

- Internal coolant supply
- TCMT TCMX TCGT TCGX TCEX TCMW
- The insert is for illustration only

BFA-TC系列

BFA-TC SERIES

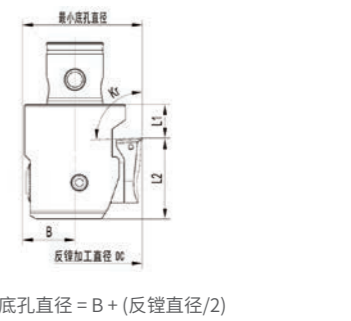

最小底孔直径 = B + (反镗直径/2)

- 内冷却液供应
- TCMT TCMX TCGT TCGX TCEX TCMW
- 刀片仅做示意

- Internal coolant supply
- TCMT TCMX TCGT TCGX TCEX TCMW
- The insert is for illustration only

技术参数 | Technical parameters

单位 | Unit: mm

订货号 Ordering code	加长垫圈组件 ³⁾ Extended washer assembly ³⁾	加长垫圈组件数量 Quantity	正镗 Positive boring			
			镗削范围 Boring Range(DC)		尺寸 Dimension	
			Min.	Max.	L	BD
GBT-BFA-020025-TC06-S-CKB1	-	-	20	25	33	19
	GBT-BPFA-WS-025A	1	25	30		
	GBT-BPFA-WS-025A	2 ²⁾	30	35		
	-	-	25	32		
GBT-BFA-025032-TC06-S-CKB2	GBT-BPFA-WS-035A	1	32	39	36	23.5
	GBT-BPFA-WS-035A	2 ²⁾	39	46		
GBT-BFA-032042-TC09-S-CKB3	-	-	32	42	43	31
	GBT-BPFA-WS-050B	1	42	52		
	GBT-BPFA-WS-050B	2 ²⁾	52	62		
	-	-	42	55	47	39
GBT-BFA-042055-TC09-S-CKB4	GBT-BPFA-WS-050B	1	52	65		
	GBT-BPFA-WS-050B	2 ²⁾	62	75		
GBT-BFA-055070-TC11-S-CKB5	-	-	55	70	57	50
	GBT-BPFA-WS-060C	1	67	82		
	GBT-BPFA-WS-060C	2 ²⁾	79	94		
	-	-	70	100	71	64
GBT-BFA-070100-TC11-S-CKB6	GBT-BPFA-WS-125C	1	95	125		
	GBT-BPFA-WS-125C	2 ²⁾	120	150		

技术参数 | Technical parameters

单位 | Unit: mm

反镗 Reverse boring					主偏角 Main declination	重量 m	刀片 Insert	接口 Coupling
镗削范围 Boring Range(DC)		尺寸 Dimension						
Min.	Max.	L1	L2	B				
-	-				92	0.07	TCMT 06T102	CKB1
27	30	11	19.5	10.5				
30	35							
-	-				92	0.12	TCMT 06T102	CKB2
32	39	14	19.5	12.5				
39	46							
40	42				92	0.24	TCMT 090204	CKB3
42	52	9	31	16.5				
52	62							
49	55				92	0.43	TCMT 090204	CKB4
52	65	13	31	20.5				
62	75							
62	70				92	0.84	TCMT 110304 TCMT 110204 ¹⁾	CKB5
67	82	11	42	26				
79	94							
78	100				92	1.83	TCMT 110304 TCMT 110204 ¹⁾	CKB6
95	125	25	42	33				
120	150							

转下页 see next page →

BFA-TC系列

BFA-TC SERIES

技术参数 | Technical parameters

单位 | Unit: mm

订货号 Ordering code	加长垫圈组件 ³⁾ Extended washer assembly ³⁾	加长垫圈组件数量 Quantity	正镗 Positive boring			
			镗削范围 Boring Range(DC)		尺寸 Dimension	
			Min.	Max.	L	BD
GBT-BFA-100160-TC11-S-CKB6	-	-	100	160	73	64
	GBT-BPFA-WS-125D	1	125	185		
	GBT-BPFA-WS-125D	2 ²⁾	150	210		
GBT-BFA-100160-TC11-S-CKB7	-	-	100	160	89	90
	GBT-BPFA-WS-125D	1	125	185		
	GBT-BPFA-WS-125D	2 ²⁾	150	210		

BFA-TC系列

BFA-TC SERIES

技术参数 | Technical parameters



单位 | Unit: mm

反镗 Reverse boring					主偏角 Main declination	重量 m	刀片 Insert	接口 Coupling
镗削范围 Boring Range(DC)		尺寸 Dimension						
Min.	Max.	L1	L2	B	Kr	Kg		
108	160	23	46	47.5	92	2.92	TCMT 110304 TCMT 110204 ¹⁾	CKB6
125	185							
150	210							
108	160	39	46	47.5	92	4.28	TCMT 110304 TCMT 110204 ¹⁾	CKB7
125	185							
150	210							

注：“1)”表示此刀片型号的刀夹需要单独订购
“2)”表示需要2个加长垫圈组件
“3)”表示加长垫圈组件需要单独订购

Note: "1)" Indicates that the cartridge matching this insert model needs to be ordered separately
"2)" Indicates that 2 extended washer assemblies are required
"3)" Indicates that the extended washer assembly needs to be ordered separately

备件 | Accessory

产品型号 Product ID	①	②			
	刀座 Adaptor	刀夹 Cartridge	刀片螺钉扳手 Key(Insert)	堵丝扳手 Key(Nozzle)	锁紧螺钉扳手 Key(Screw)
GBT-BFA-020025-TC06-S-CKB1	GBT-BPFA-CKB1-020022	GBT-BPFA-CA-0511TC06-S	242.060.35-GBT	241.009.34-GBT	247.020.100-GBT
GBT-BFA-025032-TC06-S-CKB2	GBT-BPFA-CKB2-025025	GBT-BPFA-CA-0511TC06-S	242.060.35-GBT	241.009.34-GBT	247.020.100-GBT
GBT-BFA-032042-TC09-S-CKB3	GBT-BPFA-CKB3-032026	GBT-BPFA-CA-0717TC09-S	242.070.35-GBT	241.009.34-GBT	247.030.100-GBT
GBT-BFA-042055-TC09-S-CKB4	GBT-BPFA-CKB4-042030	GBT-BPFA-CA-0717TC09-S	242.070.35-GBT	241.009.34-GBT	247.030.100-GBT
GBT-BFA-055070-TC11-S-CKB5	GBT-BPFA-CKB5-055034	GBT-BPFA-CA-1023TC1102-S ¹⁾	242.070.35-GBT	241.009.34-GBT	247.040.100-GBT
		GBT-BPFA-CA-1023TC11-S			
GBT-BFA-070100-TC11-S-CKB6	GBT-BPFA-CKB6-070048	GBT-BPFA-CA-1023TC1102-S ¹⁾	242.070.35-GBT	241.009.34-GBT	247.040.100-GBT
		GBT-BPFA-CA-1023TC11-S			
GBT-BFA-100160-TC11-S-CKB6	GBT-BPFA-CKB6-100048	GBT-BPFA-CA-1025TC1102-S ¹⁾	242.070.35-GBT	241.009.34-GBT	247.040.100-GBT
		GBT-BPFA-CA-1025TC11-S			
GBT-BFA-100160-TC11-S-CKB7	GBT-BPFA-CKB7-100064	GBT-BPFA-CA-1025TC1102-S ¹⁾	242.070.35-GBT	241.009.34-GBT	247.040.100-GBT
		GBT-BPFA-CA-1025TC11-S			

注：“1)”表示此刀夹需要单独订购；
可单独订购备件，按需询价。

Note: "1)" Indicates that the cartridge needs to be ordered separately;
The spare parts can be ordered separately. Please inquire on demand.

BFA-TC系列刀座

BFA-TC SERIES ADAPTOR

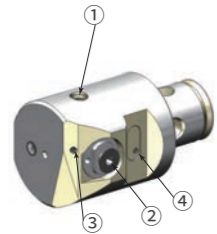

BFA-TC系列刀夹

BFA-TC SERIES CARTRIDGE

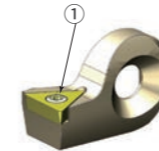

技术参数 | Technical parameters

单位 | Unit: mm

订货号 Ordering code	直径范围 Fitting Range	接口 Coupling
GBT-BPFA-CKB1-020022	20-25	CKB1
GBT-BPFA-CKB2-025025	25-32	CKB2
GBT-BPFA-CKB3-032026	32-42	CKB3
GBT-BPFA-CKB4-042030	42-55	CKB4
GBT-BPFA-CKB5-055034	55-70	CKB5
GBT-BPFA-CKB6-070048	70-100	CKB6
GBT-BPFA-CKB6-100048	100-160	CKB6
GBT-BPFA-CKB7-100064	100-160	CKB7

产品型号 Product ID	备件 Accessory				单独订购 Purchase Separately	
	① 锁紧螺钉 Screw(Lock)	② 刀夹锁紧螺钉 Screw(Cartridge)	③ 堵丝 Nozzle	④ 堵丝 Nozzle	堵丝扳手 Key(Nozzle)	锁紧螺钉扳手 Key(Screw)
GBT-BPFA-CKB1-020022	119.040.05-GBT	111.035.06-GBT	251.020.03-GBT	-	241.009.34-GBT	247.020.100-GBT
GBT-BPFA-CKB2-025025	119.040.06-GBT	111.035.06-GBT	251.020.03-GBT	-	241.009.34-GBT	247.020.100-GBT
GBT-BPFA-CKB3-032026	119.060.08-GBT	111.050.08-GBT	251.020.03-GBT	-	241.009.34-GBT	247.030.100-GBT
GBT-BPFA-CKB4-042030	119.060.10-GBT	111.050.08-GBT	251.020.03-GBT	-	241.009.34-GBT	247.030.100-GBT
GBT-BPFA-CKB5-055034	119.080.12-GBT	111.080.12-GBT	251.020.03-GBT	-	241.009.34-GBT	247.040.100-GBT
GBT-BPFA-CKB6-070048	119.080.16-GBT	111.080.12-GBT	251.020.03-GBT	-	241.009.34-GBT	247.040.100-GBT
GBT-BPFA-CKB6-100048	119.080.20-GBT	111.080.12-GBT	251.020.03-GBT	251.030.03-GBT	241.009.34-GBT	247.040.100-GBT
GBT-BPFA-CKB7-100064	119.080.20-GBT	111.080.12-GBT	251.020.03-GBT	251.030.03-GBT	241.009.34-GBT	247.040.100-GBT

可单独订购备件，按需询价。

The spare parts can be ordered separately. Please inquire on demand.

- TCMT TCMX TCGT TCGX TCEX TCMW
- 刀片仅做示意

- TCMT TCMX TCGT TCGX TCEX TCMW
- The insert is for illustration only

技术参数 | Technical parameters

单位 | Unit: mm

订货号 Ordering code	刀片 Insert	夹紧方式 Clamping
GBT-BPFA-CA-0511TC06-S	TC..06T102	S
GBT-BPFA-CA-0717TC09-S	TC..090204	S
GBT-BPFA-CA-1023TC1102-S	TC..110204	S
GBT-BPFA-CA-1023TC11-S	TC..110304	S
GBT-BPFA-CA-1025TC1102-S	TC..110204	S
GBT-BPFA-CA-1025TC11-S	TC..110304	S

产品型号 Product ID	备件 Accessory		单独订购 Purchase Separately	
	① 刀片螺钉 Screw(Insert)	刀片螺钉扳手 Key(Insert)	刀片螺钉 Screw(Insert)	刀片螺钉扳手 Key(Insert)
GBT-BPFA-CA-0511TC06-S	ILD2042-GBT	242.060.35-GBT	ILD2042-GBT	242.060.35-GBT
GBT-BPFA-CA-0717TC09-S	ILD 2264-GBT	242.070.35-GBT	ILD 2264-GBT	242.070.35-GBT
GBT-BPFA-CA-1023TC1102-S	SFS 2565-GBT	242.070.35-GBT	SFS 2565-GBT	242.070.35-GBT
GBT-BPFA-CA-1023TC11-S	SFS 2565-GBT	242.070.35-GBT	SFS 2565-GBT	242.070.35-GBT
GBT-BPFA-CA-1025TC1102-S	SFS 2565-GBT	242.070.35-GBT	SFS 2565-GBT	242.070.35-GBT
GBT-BPFA-CA-1025TC11-S	SFS 2565-GBT	242.070.35-GBT	SFS 2565-GBT	242.070.35-GBT

可单独订购备件，按需询价。

The spare parts can be ordered separately. Please inquire on demand.

BFA-TC系列加长垫圈组件

BFA-TC SERIES EXTENDED WASHER ASSEMBLY

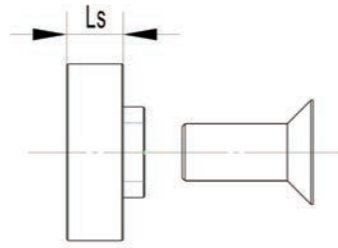
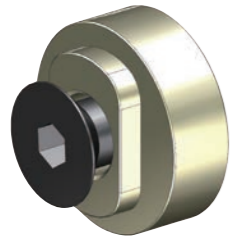

技术参数 | Technical parameters

单位 | Unit: mm

订货号 Ordering code	尺寸 Dimension	
	Ls	
GBT-BPFA-WS-025A	2.5	
GBT-BPFA-WS-035A	3.5	
GBT-BPFA-WS-050B	5	
GBT-BPFA-WS-060C	6	
GBT-BPFA-WS-125C	12.5	
GBT-BPFA-WS-125D	12.5	

备件 Accessory		单独订购 Purchase Separately	
产品型号 Product ID	锁紧螺钉 Screw(Lock)		锁紧螺钉扳手 Key(Screw)
	GBT-BPFA-WS-025A	111.035.09-GBT	
GBT-BPFA-WS-035A	111.035.09-GBT	111.035.13-GBT	247.020.100-GBT
GBT-BPFA-WS-050B	111.050.14-GBT	111.050.19-GBT	247.030.100-GBT
GBT-BPFA-WS-060C	111.080.18-GBT	111.080.25-GBT	247.040.100-GBT
GBT-BPFA-WS-125C	111.080.25-GBT	111.080.37-GBT	247.040.100-GBT
GBT-BPFA-WS-125D	111.080.25-GBT	111.080.37-GBT	247.040.100-GBT

可单独订购备件，按需询价。

The spare parts can be ordered separately. Please inquire on demand.

精镗刀BFB系列 | BFB SERIES

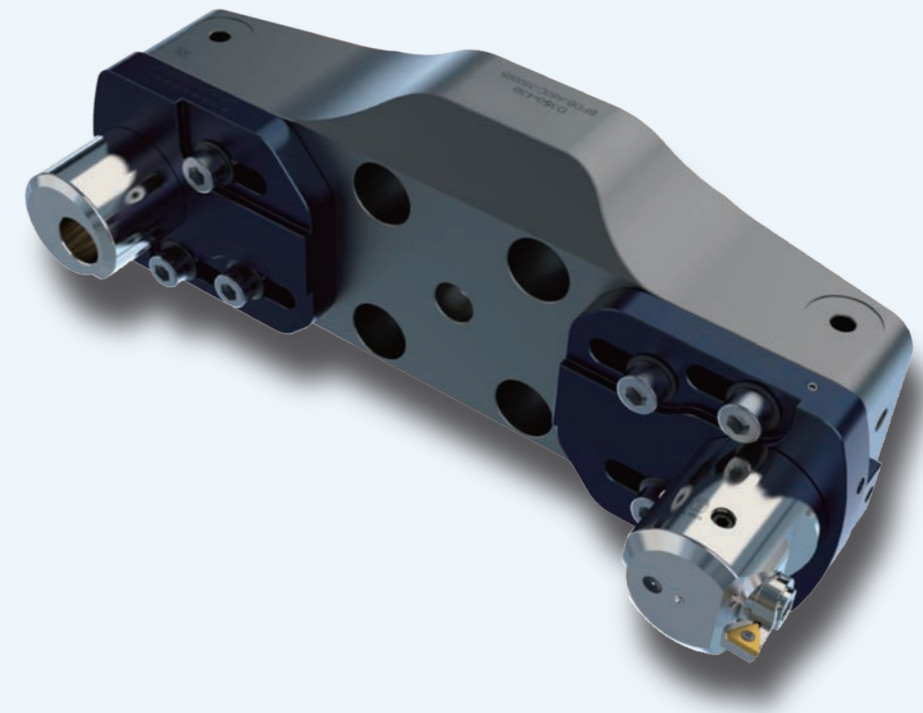

- 用于Φ160-Φ525mm的孔径精加工；
- 加工孔径公差可达IT6级；
- 航空铝桥架具有较轻的重量可减少主轴负载（与粗镗B系列通用）；
- 直径调节精度0.002mm；
- 可进行径向调节。

- Apply to Φ 160- Φ 525mm aperture finishing;
- Machining aperture tolerance can reach IT6;
- Aviation aluminum bridge with less weight can reduce the spindle load (common with rough boring BRB Series);
- Diameter adjustment accuracy: 0.002mm;
- Radial adjustment is available.

BFB-TC系列

BFB-TC SERIES

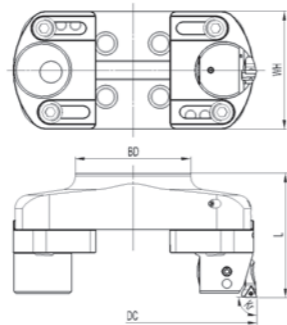
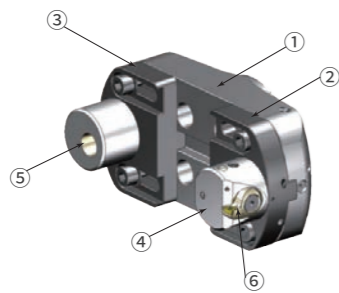

- 内冷却液供应
- TCMT TCMX TCGT TCGX TCEX TCMW
- 刀片仅做示意

- Internal coolant supply
- TCMT TCMX TCGT TCGX TCEX TCMW
- The insert is for illustration only

技术参数 | Technical parameters

单位 | Unit: mm

订货号 Ordering code	镗削范围 Boring Range(DC)			尺寸 Dimension					刀片 Insert	夹紧方式 Clamping	接口 Coupling
	Min.	Max.	Adj.	L	BD	WH	Kr	KG			
GBT-BFB-160230-TC11-S-A40C	160	230	70	118	100	104	92	4.5	TCMT 110304 TCMT 110204 ₁₎	S	A40C
GBT-BFB-215285-TC11-S-A40C	215	285	70	118	100	104	92	5	TCMT 110304 TCMT 110204 ₁₎	S	A40C

注：“1)”表示此刀片型号的刀夹需要单独订购。 Note: "1)" Indicates that the cartridge matching this insert model needs to be ordered separately.

备件 | Accessory

产品型号 Product ID	①	②	③	④	⑤	⑥
	刀座 Adaptor	滑块 Slide	配重滑块 Slide(CW)	精镗刀座 Adaptor	配重块 Counter-Weight	刀夹 Cartridge
GBT-BFB-160230-TC11-S-A40C	GBT-BPDB-A40C-160050	GBT-BPFB-SL-160	GBT-BPFB-SL-160CW	GBT-BPFB-CY34-050025	GBT-BPFB-CW-5043A	GBT-BPFA-CA-1023TC11-S GBT-BPFA-CA-1023TC1102-S ₁₎
GBT-BFB-215285-TC11-S-A40C	GBT-BPDB-A40C-215050	GBT-BPFB-SL-160	GBT-BPFB-SL-160CW	GBT-BPFB-CY34-050025	GBT-BPFB-CW-5043A	GBT-BPFA-CA-1023TC11-S GBT-BPFA-CA-1023TC1102-S ₁₎

注意：“1)”表示此刀夹需要单独订购。 Note: "1)" Indicates that the cartridge needs to be ordered separately.

产品型号 Product ID	刀片螺钉扳手 Key(Insert)	调整螺钉扳手 Key(Adj.)	锁紧螺钉扳手 Key(Screw)	螺钉扳手 Key(Screw)	螺钉扳手 Key(Screw)
GBT-BFB-160230-TC11-S-A40C	242.070.35-GBT	246.030.60-GBT	247.040.100-GBT	241.050.80-GBT	241.080.00-GBT
GBT-BFB-215285-TC11-S-A40C	242.070.35-GBT	246.030.60-GBT	247.040.100-GBT	241.050.80-GBT	241.080.00-GBT

可单独订购备件，按需询价。

The spare parts can be ordered separately. Please inquire on demand.

BFB-TC系列

BFB-TC SERIES

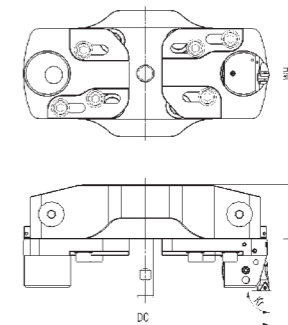
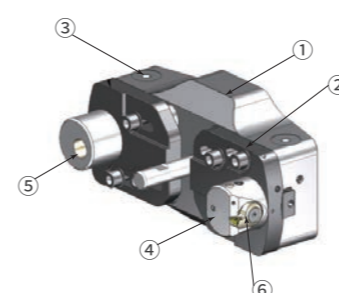

- 内冷却液供应
- TCMT TCMX TCGT TCGX TCEX TCMW
- 刀片仅做示意

- Internal coolant supply
- TCMT TCMX TCGT TCGX TCEX TCMW
- The insert is for illustration only

技术参数 | Technical parameters

单位 | Unit: mm

订货号 Ordering code	镗削范围 Boring Range(DC)			尺寸 Dimension				刀片 Insert	夹紧方式 Clamping	接口 Coupling
	Min.	Max.	Adj.	L	WH	Kr	KG			
GBT-BFB-270365-TC11-S-A60C	270	365	95	126	140	92	7.8	TCMT 110304 TCMT 110204 ₁₎	S	A60C
GBT-BFB-350445-TC11-S-A60C	350	445	95	131	140	92	9.6	TCMT 110304 TCMT 110204 ₁₎	S	A60C
GBT-BFB-430525-TC11-S-A60C	430	525	95	136	140	92	11.4	TCMT 110304 TCMT 110204 ₁₎	S	A60C

注意：“1)”表示此刀片型号的刀夹需要单独订购。 Note: "1)" Indicates that the cartridge matching this insert model needs to be ordered separately.

备件 | Accessory

产品型号 Product ID	①	②	③	④	⑤	⑥
	桥架式刀座 Brigde Adaptor	滑块 Slide	配重滑块 Slide(CW)	精镗刀座 Adaptor	配重块 Counter-Weight	刀夹 Cartridge
GBT-BFB-270365-TC11-S-A60C	GBT-BPDB-A60C-270060	GBT-BPFB-SL-270	GBT-BPFB-SL-270CW	GBT-BPFB-CY34-050025	GBT-BPFB-CW-5043A	GBT-BPFA-CA-1023TC11-S GBT-BPFA-CA-1023TC1102-S ₁₎
GBT-BFB-350445-TC11-S-A60C	GBT-BPDB-A60C-350065	GBT-BPFB-SL-270	GBT-BPFB-SL-270CW	GBT-BPFB-CY34-050025	GBT-BPFB-CW-5043A	GBT-BPFA-CA-1023TC11-S GBT-BPFA-CA-1023TC1102-S ₁₎
GBT-BFB-430525-TC11-S-A60C	GBT-BPDB-A60C-430070	GBT-BPFB-SL-270	GBT-BPFB-SL-270CW	GBT-BPFB-CY34-050025	GBT-BPFB-CW-5043A	GBT-BPFA-CA-1023TC11-S GBT-BPFA-CA-1023TC1102-S ₁₎

注意：“1)”表示此刀夹需要单独订购。 Note: "1)" Indicates that the cartridge needs to be ordered separately.

产品型号 Product ID	刀片螺钉扳手 Key(Insert)	调整螺钉扳手 Key(Adj.)	锁紧螺钉扳手 Key(Screw)	螺钉扳手 Key(Screw)	螺钉扳手 Key(Screw)
GBT-BFB-270365-TC11-S-A60C	242.070.35-GBT	246.030.60-GBT	247.040.100-GBT	241.050.80-GBT	241.080.00-GBT
GBT-BFB-350445-TC11-S-A60C	242.070.35-GBT	246.030.60-GBT	247.040.100-GBT	241.050.80-GBT	241.080.00-GBT
GBT-BFB-430525-TC11-S-A60C	242.070.35-GBT	246.030.60-GBT	247.040.100-GBT	241.050.80-GBT	241.080.00-GBT

可单独订购备件，按需询价。

The spare parts can be ordered separately. Please inquire on demand.

BFB-TC系列滑块

BFB-TC SERIES SLIDE



技术参数 | Technical parameters

单位 | Unit: mm

订货号 Ordering code	直径范围 Fitting Range
GBT-BPFB-SL-160	160-285
GBT-BPFB-SL-270	270-525

产品型号 Product ID	备件 Accessory				单独订购 Purchase Separately
	① 堵丝 Nozzle	② 堵丝 Nozzle	③ 调整螺钉 Screw(Adj.)	④ 堵丝 Nozzle	调整螺钉扳手 Key(Adj.)
GBT-BPFB-SL-160	-	251.050.05-GBT	-	-	-
GBT-BPFB-SL-270	251.040.04-GBT	251.050.05-GBT	214.020.368-GBT	254.030.10-GBT	246.030.60-GBT

可单独订购备件，按需询价。

The spare parts can be ordered separately. Please inquire on demand.

BFB-TC系列配重滑块

BFB-TC SERIES SLIDE(CW)



技术参数 | Technical parameters

单位 | Unit: mm

订货号 Ordering code	直径范围 Fitting Range
GBT-BPFB-SL-160CW	160-285
GBT-BPFB-SL-270CW	270-525

产品型号 Product ID	备件 Accessory		单独订购 Purchase Separately
	① 调整螺钉 Screw(Adj.)	② 堵丝 Nozzle	调整螺钉扳手 Key(Adj.)
GBT-BPFB-SL-160CW	-	-	-
GBT-BPFB-SL-270CW	214.020.368-GBT	254.030.10-GBT	246.030.60-GBT

可单独订购备件，按需询价。

The spare parts can be ordered separately. Please inquire on demand.

BFB-TC系列精镗刀座

BFB-TC SERIES ADAPTOR

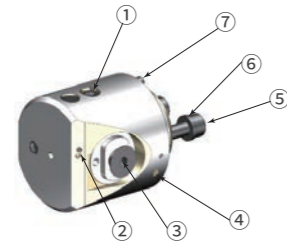

技术参数 | Technical parameters

单位 | Unit: mm

订货号 Ordering code	直径范围 Fitting Range
GBT-BPFB-CY34-050025	160-525

产品型号 Product ID	备件 Accessory							单独订购 Purchase Separately	
	① 锁紧螺钉 Screw(Lock)	② 堵丝 Nozzle	③ 刀夹锁紧螺钉 Screw(Cartridge)	④ 堵丝 Nozzle	⑤ 螺钉 Screw	⑥ 垫圈 Gasket	⑦ 圆柱销 Pin	⑧ 螺钉扳手 Key(Screw)	⑨ 锁紧螺钉扳手 Key(Screw)
GBT-BPFB-CY34-050025	119.080.12-GBT	251.020.03-GBT	118.080.12-GBT	251.030.03-GBT	113.060.20-GBT	131.060.16-GBT	171.050.12-GBT	241.050.80-GBT	247.040.100-GBT

可单独订购备件，按需询价。

The spare parts can be ordered separately. Please inquire on demand.

BFB-TC系列配重块

BFB-TC SERIES COUNTER-WEIGHT

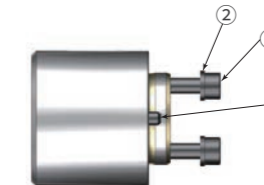

技术参数 | Technical parameters

单位 | Unit: mm

订货号 Ordering code	直径范围 Fitting Range
GBT-BPFB-CW-5043A	160-525

产品型号 Product ID	备件 Accessory			单独订购 Purchase Separately
	① 螺钉 Screw	② 垫圈 Gasket	③ 圆柱销 Pin	④ 螺钉扳手 Key(Screw)
GBT-BPFB-CW-5043A	113.060.20-GBT	131.060.16-GBT	171.050.12-GBT	241.050.80-GBT

可单独订购备件，按需询价。

The spare parts can be ordered separately. Please inquire on demand.

精镗刀BFC系列| BFC SERIES



- 配合镗刀杆使用可用于φ1-φ54mm的孔径加工;
- 加工孔径公差可达IT6级;
- 直径调节精度0.002mm。
- Used with boring bar, it can be used for φ1-φ54mm aperture machining;
- Machining aperture tolerance can reach IT6;
- Diameter adjustment accuracy: 0.002mm.

BFC-TC系列

BFC-TC SERIES

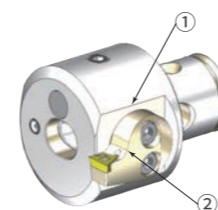

- 内冷却液供应
- TCMT TCMX TCGT TCGX TCEX TCMW
- 刀片仅做示意

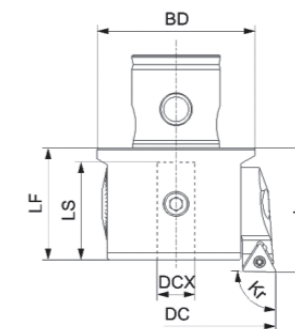



- Internal coolant supply
- TCMT TCMX TCGT TCGX TCEX TCMW
- The insert is for illustration only

技术参数 | Technical parameters

单位 | Unit: mm

订货号 Ordering code	镗削范围 Boring Range(DC)			尺寸 Dimension							接口 Coupling
	Min.	Max.	Adj.	L	LF	LS	BD	DCX	Kr	KG	
GBT-BFC-053057-TC11-S-CKB4	53	57	2	34	30	27.5	39	10	92	0.31	CKB4
GBT-BFC-063070-TC11-S-CKB5	63	70	3.5	40	36	31.5	50	12	92	0.6	CKB5
GBT-BFC-074083-TC11-S-CKB6	74	83	4.5	49	45	40.5	64	16	92	1.3	CKB6

备件 | Accessory

产品型号 Product ID	①	②		
	精镗刀座 Adaptor	刀夹 Cartridge	刀片螺钉扳手 Key(Insert)	锁紧螺钉扳手 Key(Screw)
GBT-BFC-053057-TC11-S-CKB4	GBT-BPFC-CKB4-010030	GBT-BPFC-CA-1320TC1102-S1) GBT-BPFC-CA-1320TC11-S	242.070.35-GBT	247.030.100-GBT
GBT-BFC-063070-TC11-S-CKB5	GBT-BPFC-CKB5-012036	GBT-BPFC-CA-1422TC1102-S1) GBT-BPFC-CA-1422TC11-S	242.070.35-GBT	247.040.100-GBT
GBT-BFC-074083-TC11-S-CKB6	GBT-BPFC-CKB6-016045	GBT-BPFC-CA-1526TC1102-S1) GBT-BPFC-CA-1526TC11-S	242.070.35-GBT	247.050.100-GBT

注：“1”表示此刀夹需要单独订购
可单独订购备件，按需询价。

Note: "1" Indicates that the cartridge needs to be ordered separately
The spare parts can be ordered separately. Please inquire on demand.

BFC-TC系列精镗刀座

BFC-TC SERIES ADAPTOR

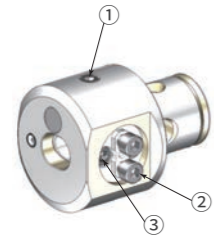

技术参数 | Technical parameters

单位 | Unit: mm

订货号 Ordering code	直径范围 Fitting Range
GBT-BPFC-CKB4-010030	53-57
GBT-BPFC-CKB5-012036	63-70
GBT-BPFC-CKB6-016045	74-83

产品型号 Product ID	备件 Accessory			单独订购 Purchase Separately
	① 锁紧螺钉 Screw(Lock)	② 刀夹锁紧螺钉 Screw(Cartridge)	③ 锁紧螺钉 Screw (Lock)	 锁紧螺钉扳手 Key(Screw)
GBT-BPFC-CKB4-010030	119.060.08-GBT	113.040.08-GBT	259.060.10-GBT	247.030.100-GBT
GBT-BPFC-CKB5-012036	119.080.10-GBT	113.050.10-GBT	259.080.10-GBT	247.040.100-GBT
GBT-BPFC-CKB6-016045	119.100.12-GBT	113.060.12-GBT	259.100.12-GBT	247.050.100-GBT

可单独订购备件，按需询价。

The spare parts can be ordered separately. Please inquire on demand.

BFC-TC系列刀夹

BFC-TC SERIES CARTRIDGE

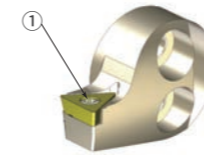

- TCMT TCMX TCGT TCGX TCEX TCMW
- 刀片仅做示意

- TCMT TCMX TCGT TCGX TCEX TCMW
- The insert is for illustration only

技术参数 | Technical parameters

单位 | Unit: mm

订货号 Ordering code	刀片 Insert	夹紧方式 Clamping
GBT-BPFC-CA-1320TC1102-S	TC.110204	S
GBT-BPFC-CA-1320TC11-S	TC.110304	S
GBT-BPFC-CA-1422TC1102-S	TC..110204	S
GBT-BPFC-CA-1422TC11-S	TC..110304	S
GBT-BPFC-CA-1526TC1102-S	TC..110204	S
GBT-BPFC-CA-1526TC11-S	TC..110304	S

产品型号 Product ID	备件 Accessory	
	① 刀片螺钉 Screw(Insert)	单独订购 Purchase Separately
		 刀片螺钉扳手 Key(Insert)
GBT-BPFC-CA-1320TC1102-S	SFS 2565-GBT	242.070.35-GBT
GBT-BPFC-CA-1320TC11-S	SFS 2565-GBT	242.070.35-GBT
GBT-BPFC-CA-1422TC1102-S	SFS 2565-GBT	242.070.35-GBT
GBT-BPFC-CA-1422TC11-S	SFS 2565-GBT	242.070.35-GBT
GBT-BPFC-CA-1526TC1102-S	SFS 2565-GBT	242.070.35-GBT
GBT-BPFC-CA-1526TC11-S	SFS 2565-GBT	242.070.35-GBT

可单独订购备件，按需询价。

The spare parts can be ordered separately. Please inquire on demand.

接口简图

COUPLING DIAGRAM

芯轴接口 | Arbor

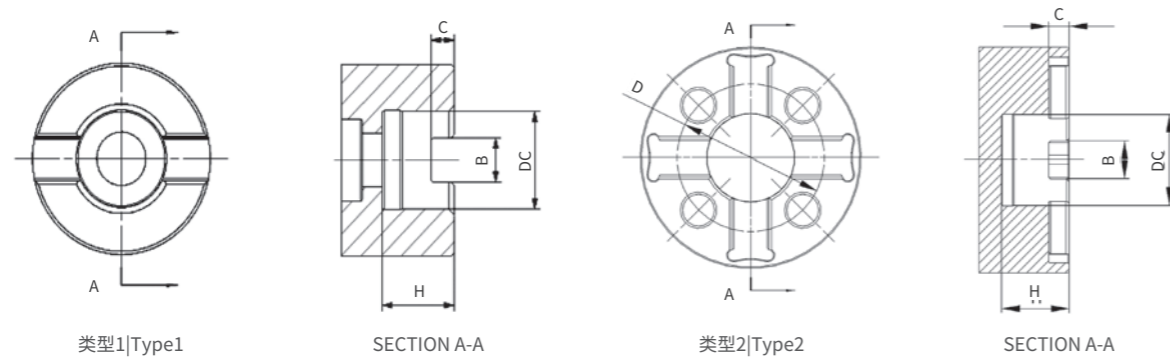

技术参数 | Technical parameters

单位 | Unit: mm

接口型号 Ordering code	接口尺寸 Dimension					接口 Coupling
	DC	H	B	C	D	
A22A	22	24	10.4	6.55	-	1
A32A	32	25.5	14.4	8	-	1
A40C	40	30	16.4	9	66.7	2
A60C	60	30	25.7	14	101.6	2

CKB接口 | CK

产品信息 | SPECIFICATION

接口型号 Ordering code	接口尺寸 Dimension	
	DC	L
CKB1	11	13
CKB2	14	16
CKB3	18	20
CKB4	22	24
CKB5	28	30
CKB6	36	40
CKB7	46	50

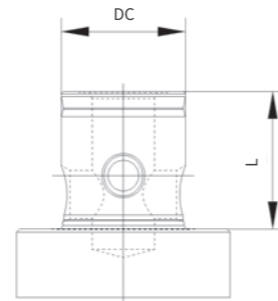

BFC系列镗杆 | BORING BAR BFC SERIES

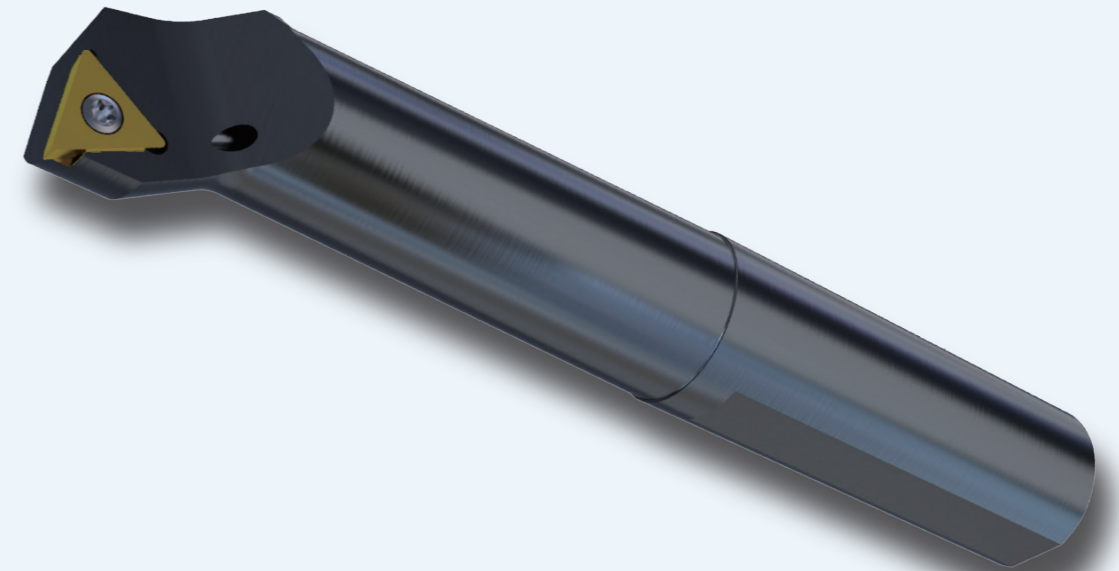

- 镗杆配合BFC系列精镗刀使用;
- 镗杆本身带有内冷孔。

- The boring bar is used with BFC series fine boring tools.
- It has internal cooling holes.

命名方式
Naming And Coding Rules

GBT CY 10 11 039 TC06

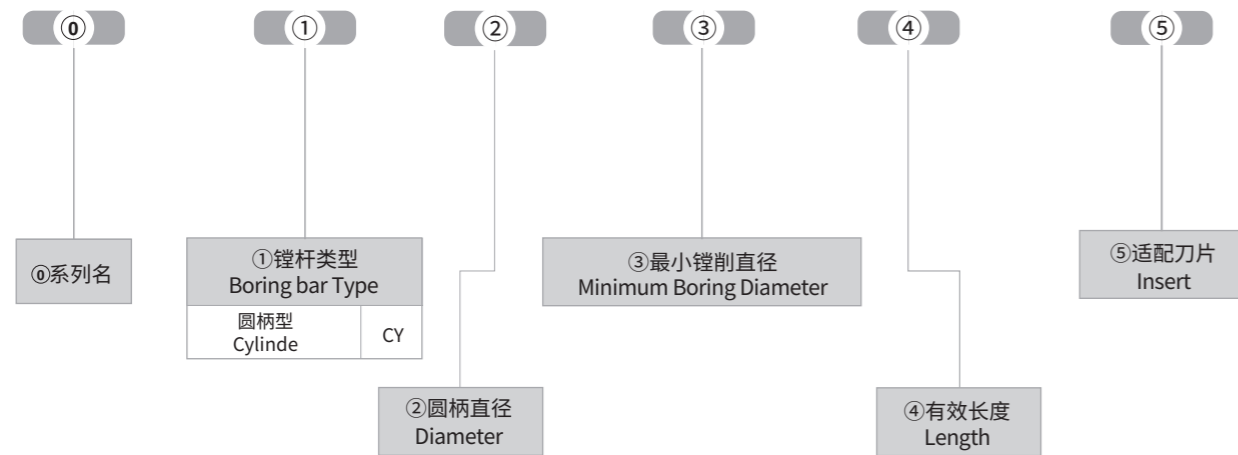

BFC-TC系列镗杆

BORING BAR BFC-TC SERIES

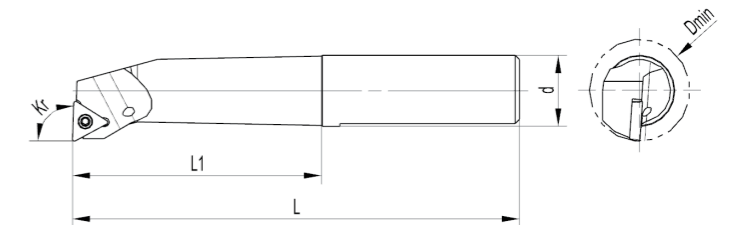
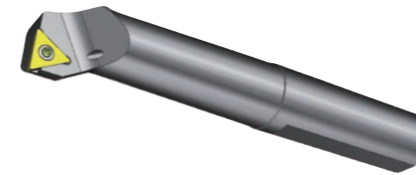

- 内冷却液供应
- TCMT TCMX TCGT TCGX TCMW
- 刀片仅做示意

- Internal coolant supply
- TCMT TCMX TCGT TCGX TCMW
- The insert is for illustration only

技术参数 | Technical parameters

单位 | Unit: mm

订货号 Ordering code	尺寸 Dimension				主偏角 Main Declination Kr	重量 Weigh KG	刀片 Insert
	Dmin	d	L1	L			
GBT-CY10-08028TC06	8	10	28	59	92°	0.036	TCMT 06T102
GBT-CY10-11039TC06	11	10	39	69	92°	0.048	TCMT 06T102
GBT-CY10-14042TC09	14	10	42	72	92°	0.06	TCMT 090204
GBT-CY10-17060TC09	17	10	60	90	92°	0.071	TCMT 090204
GBT-CY12-08028TC06	8	12	28	64	92°	0.046	TCMT 06T102
GBT-CY12-11039TC06	11	12	39	75	92°	0.058	TCMT 06T102
GBT-CY12-14042TC09	14	12	42	78	92°	0.07	TCMT 090204
GBT-CY12-17060TC09	17	12	60	96	92°	0.081	TCMT 090204
GBT-CY12-20060TC09	20	12	60	96	92°	0.082	TCMT 090204
GBT-CY16-08028TC06	8	16	28	74	92°	0.084	TCMT 06T102
GBT-CY16-11039TC06	11	16	39	85	92°	0.094	TCMT 06T102
GBT-CY16-14049TC09	14	16	49	95	92°	0.118	TCMT 090204
GBT-CY16-17056TC09	17	16	56	102	92°	0.129	TCMT 090204
GBT-CY16-20080TC09	20	16	80	126	92°	0.163	TCMT 090204
GBT-CY16-23080TC09	23	16	80	126	92°	0.163	TCMT 090204
GBT-CY16-26080TC09	26	16	80	126	92°	0.164	TCMT 090204

备件 | Accessory

刀片 Insert	刀片螺钉 Screw(Insert)	刀片螺钉扳手 Key(Insert)
TCMT 06T102	ILD 2042-GBT	242.060.35-GBT
TCMT 090204	ILD 2264-GBT	242.070.35-GBT

可单独订购备件，按需询价。

The spare parts can be ordered separately. Please inquire on demand.

镗刀转接柄 | BORING TOOL ADAPTOR HOLDER

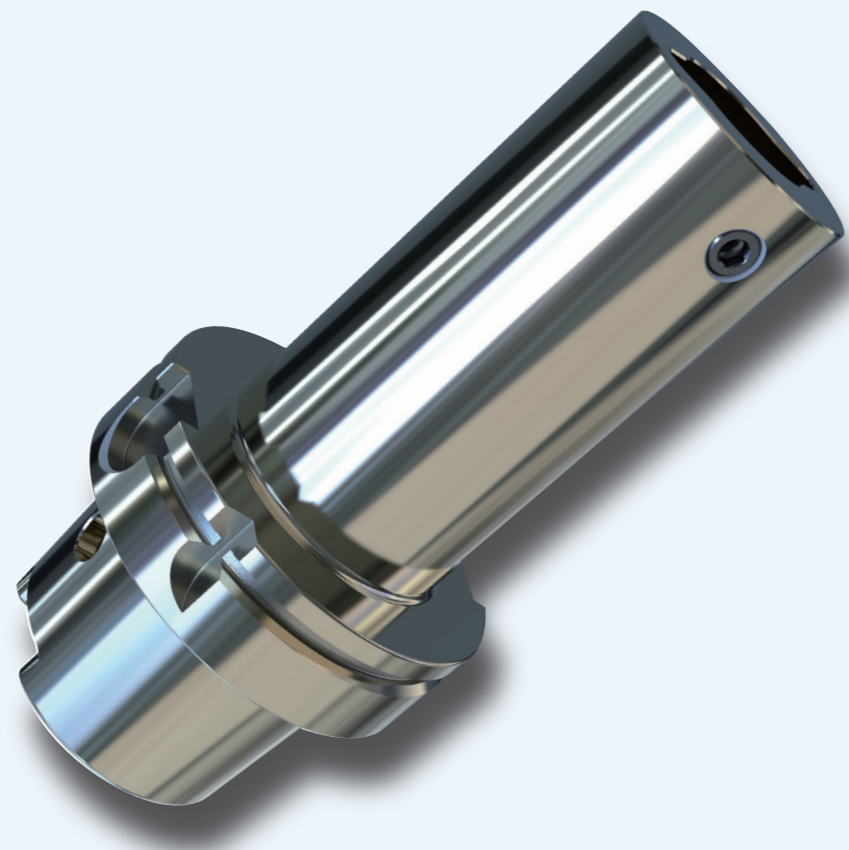

● 包含两种系列：CK基础柄系列 芯轴基础柄系列。

● Two connection series: CK, Arbor.

命名方式 Naming And Coding Rules

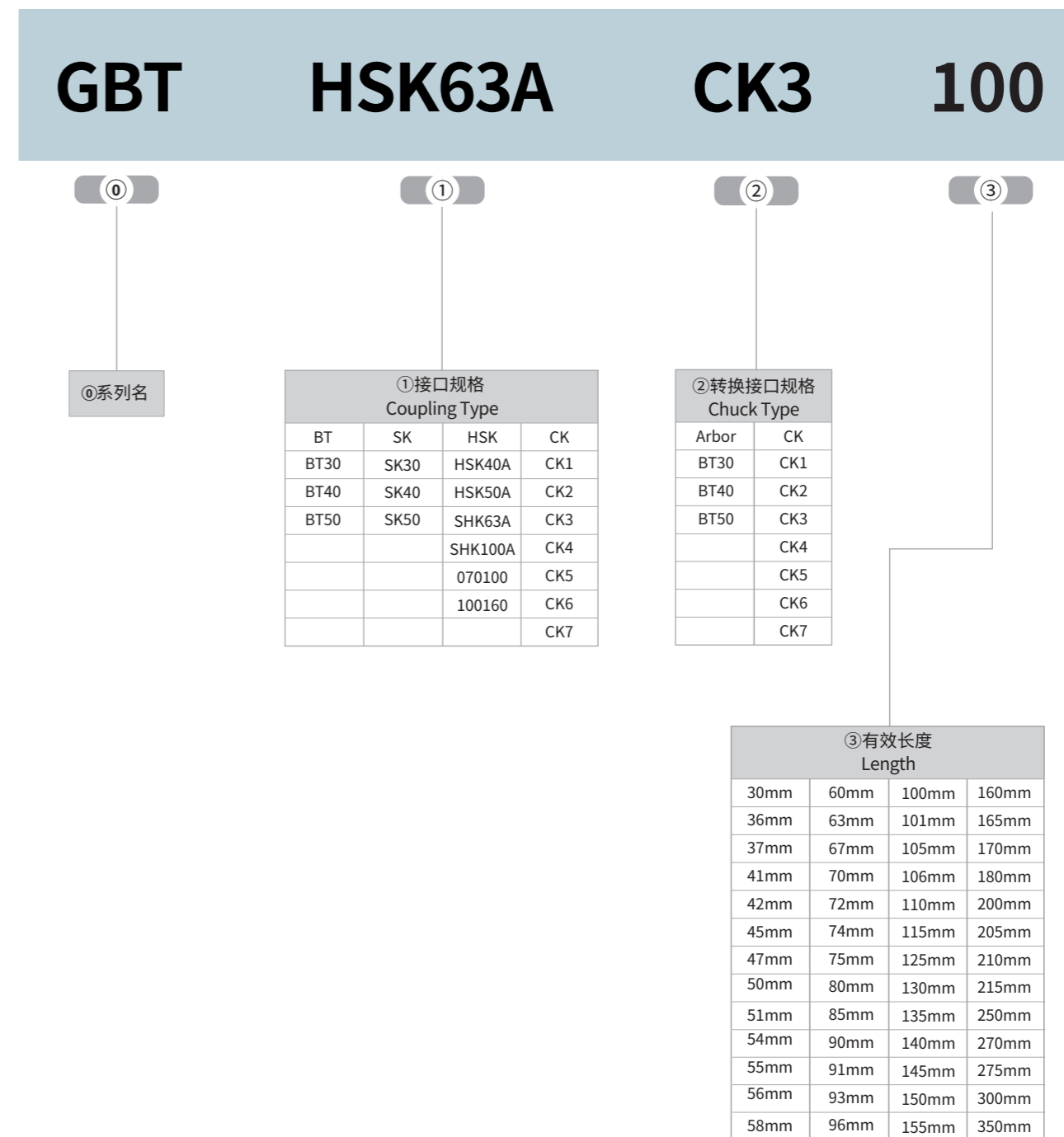

注：镗刀头接口规格CKB与镗刀接柄CK属于同一接口规格，配合使用。

Note: Boring tool head with CKB interface can match boring tool connection CK series. Their interface specifications are consistent.

CK基础柄 HSK系列

CK CONNECTION WITH HSK ADAPTOR

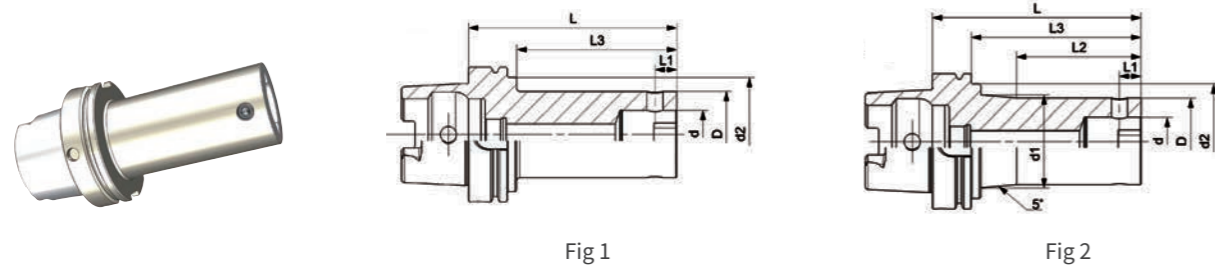

技术参数 | Technical parameters

单位 | Unit: mm

订货号 Ordering code	Fig	D	d	d1	d2	L1	L2	L3	L	侧固螺钉 Screw (Side-fixed)	扳手 Key	重量 Weight
GBT-HSK63A-CK1-070	1	19	11	-	-	5.05	-	-	70	M5×5-30D-GBT	L025-GBT	0.8
GBT-HSK63A-CK1-100	2	19	11	23.5	-	5.05	50	-	100	M5×5-30D-GBT	L025-GBT	0.9
GBT-HSK63A-CK2-075	1	24	14	-	-	6.45	-	-	75	M5×6-30D-GBT	L025-GBT	0.9
GBT-HSK63A-CK2-100	1	24	14	-	-	6.45	-	-	100	M5×6-30D-GBT	L025-GBT	1
GBT-HSK63A-CK2-130	2	24	14	31	-	6.45	65	-	130	M5×6-30D-GBT	L025-GBT	1.1
GBT-HSK63A-CK3-080	1	31	18	-	-	7.9	-	-	80	M6×9-30D-GBT	L03-GBT	1
GBT-HSK63A-CK3-100	1	31	18	-	-	7.9	-	-	100	M6×9-30D-GBT	L03-GBT	1.1
GBT-HSK63A-CK3-135	2	31	18	37	-	7.9	75	-	135	M6×9-30D-GBT	L03-GBT	1.3
GBT-HSK63A-CK3-165	2	31	18	41	-	7.9	85	-	165	M6×9-30D-GBT	L03-GBT	1.4
GBT-HSK63A-CK4-070	1	39	22	-	-	10	-	-	70	M8×12-30D-GBT	L04-GBT	1
GBT-HSK63A-CK4-100	1	39	22	-	-	10	-	-	100	M8×12-30D-GBT	L04-GBT	1.3
GBT-HSK63A-CK4-150	2	39	22	44	-	10	95	-	150	M8×12-30D-GBT	L04-GBT	1.7
GBT-HSK63A-CK4-170	2	39	22	47.5	-	10	95	-	170	M8×12-30D-GBT	L04-GBT	1.9
GBT-HSK63A-CK5-080	1	50	28	-	-	13	-	-	80	M10×16-30D-GBT	L05-GBT	1.4
GBT-HSK63A-CK5-100	1	50	28	-	-	13	-	-	100	M10×16-30D-GBT	L05-GBT	1.8
GBT-HSK63A-CK5-150	1	50	28	-	-	13	-	-	150	M10×16-30D-GBT	L05-GBT	2.2
GBT-HSK63A-CK5-180	1	50	28	-	-	13	-	-	180	M10×16-30D-GBT	L05-GBT	2.7
GBT-HSK63A-CK6-100	1	64	36	-	-	16	-	-	100	M12×20-30D-GBT	L06-GBT	2.2
GBT-HSK63A-CK6-150	1	64	36	-	-	16	-	-	150	M12×20-30D-GBT	L06-GBT	2.8
GBT-HSK63A-CK6-180	1	64	36	-	-	16	-	-	180	M12×20-30D-GBT	L06-GBT	3.3
GBT-HSK100A-CK1-080	1	19	11	-	65	5.05	-	43	80	M5×5-30D-GBT	L025-GBT	2.4

转下页 see next page →

CK基础柄 HSK系列

CK CONNECTION WITH HSK ADAPTOR

技术参数 | Technical parameters

单位 | Unit: mm

订货号 Ordering code	Fig	D	d	d1	d2	L1	L2	L3	L	侧固螺钉 Screw (Side-fixed)	扳手 Key	重量 Weight
GBT-HSK100A-CK1-115	2	19	11	24	65	5.05	50	78	115	M5×5-30D-GBT	L025-GBT	2.5
GBT-HSK100A-CK1-145	2	19	11	27.5	65	5.05	60	108	145	M5×5-30D-GBT	L025-GBT	2.6
GBT-HSK100A-CK2-080	1	24	14	-	65	6.45	-	43	80	M5×6-30D-GBT	L025-GBT	2.45
GBT-HSK100A-CK2-105	1	24	14	-	65	6.45	-	68	105	M5×6-30D-GBT	L025-GBT	2.5
GBT-HSK100A-CK2-135	2	24	14	30	65	6.45	65	98	135	M5×6-30D-GBT	L025-GBT	2.6
GBT-HSK100A-CK2-165	2	24	14	33.5	65	6.45	75	128	165	M5×6-30D-GBT	L025-GBT	2.7
GBT-HSK100A-CK3-085	1	31	18	-	65	7.9	-	46	85	M6×9-30D-GBT	L03-GBT	2.6
GBT-HSK100A-CK3-110	1	31	18	-	65	7.9	-	71	110	M6×9-30D-GBT	L03-GBT	2.7
GBT-HSK100A-CK3-140	2	31	18	35.5	-	7.9	75	101	140	M6×9-30D-GBT	L03-GBT	2.8
GBT-HSK100A-CK3-170	2	31	18	41	-	7.9	85	-	170	M6×9-30D-GBT	L03-GBT	2.9
GBT-HSK100A-CK4-100	1	39	22	-	-	10	-	-	100	M8×12-30D-GBT	L04-GBT	2.8
GBT-HSK100A-CK4-160	2	39	22	47	-	10	85	-	160	M8×12-30D-GBT	L04-GBT	3.5
GBT-HSK100A-CK4-205	2	39	22	50.5	-	10	110	-	205	M8×12-30D-GBT	L04-GBT	4
GBT-HSK100A-CK5-090	1	50	28	-	-	13	-	-	90	M10×16-30D-GBT	L05-GBT	3.5
GBT-HSK100A-CK5-165	1	50	28	-	-	13	-	-	165	M10×16-30D-GBT	L05-GBT	4.2
GBT-HSK100A-CK5-210	2	50	28	61	-	13	120	-	210	M10×16-30D-GBT	L05-GBT	4.8
GBT-HSK100A-CK5-270	2	50	28	69.5	-	13	130	-	270	M10×16-30D-GBT	L05-GBT	5.6
GBT-HSK100A-CK6-085	1	64	36	-	-	16	-	-	85	M12×20-30D-GBT	L06-GBT	4.2
GBT-HSK100A-CK6-155	1	64	36	-	-	16	-	-	155	M12×20-30D-GBT	L06-GBT	5
GBT-HSK100A-CK6-215	1	64	36	-	-	16	-	-	215	M12×20-30D-GBT	L06-GBT	5.8
GBT-HSK100A-CK6-250	1	64	36	-	-	16	-	-	250	M12×20-30D-GBT	L06-GBT	6.2
GBT-HSK100A-CK6-300	2	64	36	80	-	16	180	-	300	M12×20-30D-GBT	L06-GBT	7.1
GBT-HSK100A-CK7-125	1	90	46	-	-	19.15	-	-	125	M20×29-30D-GBT	L10-GBT	5.22
GBT-HSK100A-CK7-200	1	90	46	-	-	19.15	-	-	200	M20×29-30D-GBT	L10-GBT	6.88
GBT-HSK100A-CK7-275	1	90	46	-	-	19.15	-	-	275	M20×29-30D-GBT	L10-GBT	8.26

CK基础柄 BT系列

CK CONNECTION WITH BT ADAPTOR

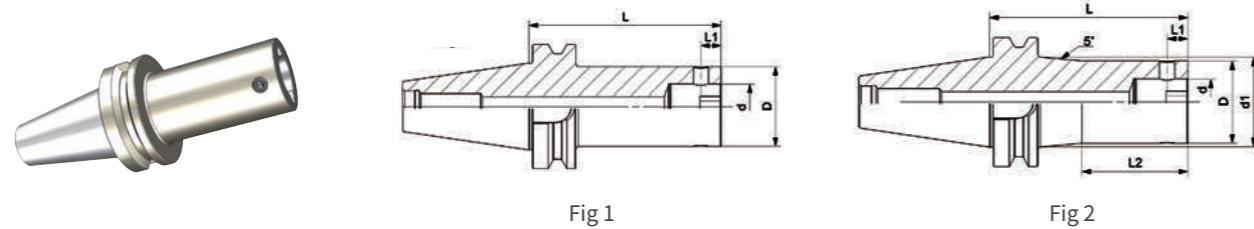

技术参数 | Technical parameters

单位 | Unit: mm

订货号 Ordering code	Fig	D	d	d1	L1	L2	L	侧固螺钉 Screw (Side-fixed)	扳手 Key	重量 Weight
GBT-BT30-CK1-055	1	19	11	-	5.05	-	55	M5×5-30D-GBT	L025-GBT	0.42
GBT-BT30-CK1-070	1	19	11	-	5.05	-	70	M5×5-30D-GBT	L025-GBT	0.45
GBT-BT30-CK2-080	1	24	14	-	6.45	-	80	M5×6-30D-GBT	L025-GBT	0.54
GBT-BT30-CK3-080	1	31	18	-	7.9	-	80	M6×9-30D-GBT	L03-GBT	0.68
GBT-BT30-CK4-070	1	39	22	-	10	-	70	M8×12-30D-GBT	L04-GBT	0.68
GBT-BT30-CK5-070	1	50	28	-	13	-	70	M10×16-30D-GBT	L05-GBT	0.88
GBT-BT30-CK6-060	1	64	36	-	16	-	60	M12×20-30D-GBT	L06-GBT	0.89
GBT-BT40-CK1-070	1	19	11	-	5.05	-	70	M5×5-30D-GBT	L025-GBT	1.03
GBT-BT40-CK1-100	2	19	11	20.7	5.05	60	100	M5×5-30D-GBT	L025-GBT	1.1
GBT-BT40-CK1-130	2	19	11	25.5	5.05	60	130	M5×5-30D-GBT	L025-GBT	1.18
GBT-BT40-CK2-075	1	24	14	-	6.45	-	75	M5×6-30D-GBT	L025-GBT	1.1
GBT-BT40-CK2-100	1	24	14	-	6.45	-	100	M5×6-30D-GBT	L025-GBT	1.18
GBT-BT40-CK2-130	2	24	14	30	6.45	65	130	M5×6-30D-GBT	L025-GBT	1.33
GBT-BT40-CK2-160	2	24	14	33.6	6.45	75	160	M5×6-30D-GBT	L02-GBT5	1.49
GBT-BT40-CK3-080	1	31	18	-	7.9	-	80	M6×9-30D-GBT	L03-GBT	1.22
GBT-BT40-CK3-100	1	31	18	-	7.9	-	100	M6×9-30D-GBT	L03-GBT	1.32
GBT-BT40-CK3-135	2	31	18	34.5	7.9	75	135	M6×9-30D-GBT	L03-GBT	1.54
GBT-BT40-CK3-165	2	31	18	39.7	7.9	85	165	M6×9-30D-GBT	L03-GBT	1.76
GBT-BT40-CK4-070	1	39	22	-	10	-	70	M8×12-30D-GBT	L04-GBT	1.21
GBT-BT40-CK4-100	1	39	22	-	10	-	100	M8×12-30D-GBT	L04-GBT	1.46
GBT-BT40-CK4-150	2	39	22	43.4	10	85	150	M8×12-30D-GBT	L04-GBT	1.9

转下页 see next page →

CK基础柄 BT系列

CK CONNECTION WITH BT ADAPTOR

技术参数 | Technical parameters

单位 | Unit: mm

订货号 Ordering code	Fig	D	d	d1	L1	L2	L	侧固螺钉 Screw (Side-fixed)	扳手 Key	重量 Weight
GBT-BT40-CK4-170	2	39	22	46.9	10	95	170	M8×12-30D-GBT	L04-GBT	2.16
GBT-BT40-CK5-060	1	50	28	-	13	-	60	M10×16-30D-GBT	L05-GBT	1.22
GBT-BT40-CK5-080	1	50	28	-	13	-	80	M10×16-30D-GBT	L05-GBT	1.52
GBT-BT40-CK5-100	1	50	28	-	13	-	100	M10×16-30D-GBT	L05-GBT	1.8
GBT-BT40-CK5-150	1	50	28	-	13	-	150	M10×16-30D-GBT	L05-GBT	2.52
GBT-BT40-CK5-180	1	50	28	-	13	-	180	M10×16-30D-GBT	L05-GBT	2.9
GBT-BT40-CK6-055	1	64	36	-	16	-	55	M12×20-30D-GBT	L06-GBT	1.22
GBT-BT40-CK6-100	1	64	36	-	16	-	100	M12×20-30D-GBT	L06-GBT	2.29
GBT-BT40-CK6-150	1	64	36	-	16	-	150	M12×20-30D-GBT	L06-GBT	3.5
GBT-BT40-CK6-180	1	64	36	-	16	-	180	M12×20-30D-GBT	L06-GBT	4.22
GBT-BT50-CK1-080	1	19	11	-	5.05	-	80	M5×5-30D-GBT	L025-GBT	3.2
GBT-BT50-CK1-115	2	19	11	20.7	5.05	50	115	M5×5-30D-GBT	L025-GBT	3.73
GBT-BT50-CK1-145	2	19	11	26	5.05	60	145	M5×5-30D-GBT	L025-GBT	4.2
BGBT-T50-CK2-080	1	24	14	-	6.45	-	80	M5×6-30D-GBT	L025-GBT	3.68
GBT-BT50-CK2-105	1	24	14	-	6.45	-	105	M5×6-30D-GBT	L025-GBT	3.78
GBT-BT50-CK2-135	2	24	14	26.6	6.45	65	135	M5×6-30D-GBT	L025-GBT	3.89
GBT-BT50-CK2-165	2	24	14	31.9	6.45	75	165	M5×6-30D-GBT	L025-GBT	4.08
GBT-BT50-CK3-085	1	31	18	-	7.9	-	85	M6×9-30D-GBT	L03-GBT	3.8
GBT-BT50-CK3-110	1	31	18	-	7.9	-	110	M6×9-30D-GBT	L03-GBT	3.95
GBT-BT50-CK3-140	2	31	18	32.7	7.9	75	140	M6×9-30D-GBT	L03-GBT	4.09
GBT-BT50-CK3-170	2	31	18	38	7.9	85	170	M6×9-30D-GBT	L03-GBT	4.31
GBT-BT50-CK4-100	1	39	22	-	10	-	100	M8×12-30D-GBT	L04-GBT	3.98
GBT-BT50-CK4-160	2	39	22	42.5	10	85	160	M8×12-30D-GBT	L04-GBT	4.5
GBT-BT50-CK4-205	2	39	22	50	10	95	205	M8×12-30D-GBT	L04-GBT	5.13
GBT-BT50-CK5-090	1	50	28	-	13	-	90	M10×16-30D-GBT	L05-GBT	4.3
GBT-BT50-CK5-165	1	50	28	-	13	-	165	M10×16-30D-GBT	L05-GBT	5.2
GBT-BT50-CK5-210	2	50	28	57.8	13	120	210	M10×16-30D-GBT	L05-GBT	5.92
GBT-BT50-CK5-270	2	50	28	68.4	13	120	270	M10×16-30D-GBT	L05-GBT	7.23
GBT-BT50-CK6-085	1	64	36	-	16	-	85	M12×20-30D-GBT	L06-GBT	4.28
GBT-BT50-CK6-155	1	64	36	-	16	-	155	M12×20-30D-GBT	L06-GBT	5.97
GBT-BT50-CK6-215	1	64	36	-	16	-	215	M12×20-30D-GBT	L06-GBT	7.43
GBT-BT50-CK6-250	1	64	36	-	16	-	250	M12×20-30D-GBT	L06-GBT	8.27
GBT-BT50-CK6-300	2	64	36	80.5	16	160	300	M12×20-30D-GBT	L06-GBT	10.21
GBT-BT50-CK6-350	2	64	36	90	16	160	350	M12×20-30D-GBT	L06-GBT	12.9
GBT-BT50-CK7-085	1	90	46	-	19.15	-	85	M20×29-30D-GBT	L10-GBT	4.96
GBT-BT50-CK7-150	1	90	46	-	19.15	-	150	M20×29-30D-GBT	L10-GBT	6.52
GBT-BT50-CK7-210	1	90	46	-	19.15	-	210	M20×29-30D-GBT	L10-GBT	8.55
GBT-BT50-CK7-250	1	90	46	-	19.15	-	250	M20×29-30D-GBT	L10-GBT	10.35
GBT-BT50-CK7-300	1	90	46	-	19.15	-	300	M20×29-30D-GBT	L10-GBT	12.55
GBT-BT50-CK7-350	1	90	46	-	19.15	-	350	M20×29-30D-GBT	L10-GBT	13.25

CK基础柄 SK系列

CK CONNECTION WITH SK ADAPTOR

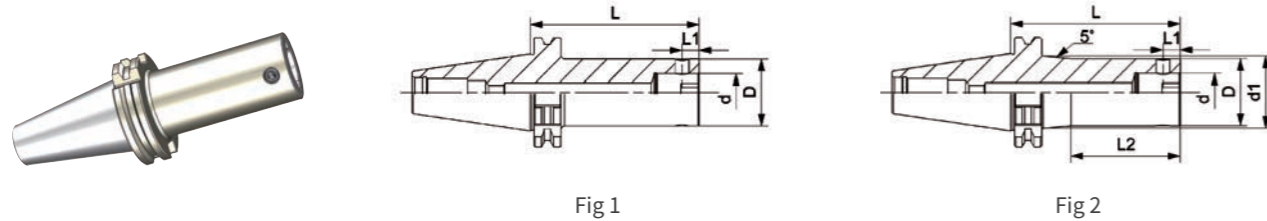

技术参数 | Technical parameters

单位 | Unit: mm

订货号 Ordering code	Fig	D	d	d1	L1	L2	L	侧固螺钉 Screw (Side-fixed)	扳手 Key	重量 Weight
GBT-SK30-CK1-055	1	19	11	-	5.05	-	55	M5×5-30D-GBT	L025-GBT	0.42
GBT-SK30-CK1-070	1	19	11	-	5.05	-	70	M5×5-30D-GBT	L025-GBT	0.45
GBT-SK30-CK2-080	1	24	14	-	6.45	-	80	M5×6-30D-GBT	L025-GBT	0.54
GBT-SK30-CK3-080	1	31	18	-	7.9	-	80	M6×9-30D-GBT	L03-GBT	0.68
GBT-SK30-CK4-070	1	39	22	-	10	-	70	M8×12-30D-GBT	L04-GBT	0.68
GBT-SK30-CK5-070	1	50	28	-	13	-	70	M10×16-30D-GBT	L05-GBT	0.88
GBT-SK30-CK6-080	1	64	36	-	16	-	80	M12×20-30D-GBT	L06-GBT	0.89
GBT-SK40-CK1-070	1	19	11	-	5.05	-	70	M5×5-30D-GBT	L025-GBT	1.03
GBT-SK40-CK1-100	2	19	11	20.7	5.05	60	100	M5×5-30D-GBT	L025-GBT	1.1
GBT-SK40-CK2-075	1	24	14	-	6.45	-	75	M5×6-30D-GBT	L025-GBT	1.1
GBT-SK40-CK2-100	1	24	14	-	6.45	-	100	M5×6-30D-GBT	L025-GBT	1.18
GBT-SK40-CK2-130	2	24	14	28.3	6.45	75	130	M5×6-30D-GBT	L025-GBT	1.33
GBT-SK40-CK2-160	2	24	14	33.6	6.45	75	160	M5×6-30D-GBT	L025-GBT	1.49
GBT-SK40-CK3-080	1	31	18	-	7.9	-	80	M6×9-30D-GBT	L03-GBT	1.22
GBT-SK40-CK3-100	1	31	18	-	7.9	-	100	M6×9-30D-GBT	L03-GBT	1.32
GBT-SK40-CK3-135	2	31	18	34.5	7.9	85	135	M6×9-30D-GBT	L03-GBT	1.54
GBT-SK40-CK3-165	2	31	18	39.7	7.9	85	165	M6×9-30D-GBT	L03-GBT	1.76
GBT-SK40-CK4-070	1	39	22	-	10	-	70	M8×12-30D-GBT	L04-GBT	1.21
GBT-SK40-CK4-100	1	39	22	-	10	-	100	M8×12-30D-GBT	L04-GBT	1.46
GBT-SK40-CK4-150	2	39	22	43.4	10	95	150	M8×12-30D-GBT	L04-GBT	1.9
GBT-SK40-CK4-170	2	39	22	46.9	10	95	170	M8×12-30D-GBT	L04-GBT	2.16

转下页 see next page →

CK基础柄 SK系列

CK CONNECTION WITH SK ADAPTOR

技术参数 | Technical parameters

单位 | Unit: mm

订货号 Ordering code	Fig	D	d	d1	L1	L2	L	侧固螺钉 Screw (Side-fixed)	扳手 Key	重量 Weight
GBT-SK40-CK5-080	1	50	28	-	13	-	80	M10×16-30D-GBT	L05-GBT	1.52
GBT-SK40-CK5-100	1	50	28	-	13	-	100	M10×16-30D-GBT	L05-GBT	1.8
GBT-SK40-CK5-150	1	50	28	-	13	-	150	M10×16-30D-GBT	L05-GBT	2.52
GBT-SK40-CK5-180	1	50	28	-	13	-	180	M10×16-30D-GBT	L05-GBT	2.9
GBT-SK40-CK6-090	1	64	36	-	16	-	90	M12×20-30D-GBT	L06-GBT	2.29
GBT-SK40-CK6-150	1	64	36	-	16	-	150	M12×20-30D-GBT	L06-GBT	3.5
GBT-SK40-CK6-180	1	64	36	-	16	-	180	M12×20-30D-GBT	L06-GBT	4.22
GBT-SK50-CK1-080	2	19	11	20.7	5.05	-	80	M5×5-30D-GBT	L025-GBT	3.6
GBT-SK50-CK1-115	2	19	11	20.7	5.05	60	115	M5×5-30D-GBT	L025-GBT	3.73
GBT-SK50-CK1-145	2	19	11	26	5.05	60	145	M5×5-30D-GBT	L025-GBT	4.2
GBT-SK50-CK2-080	1	24	14	-	6.45	-	80	M5×6-30D-GBT	L025-GBT	3.6
GBT-SK50-CK2-105	1	24	14	-	6.45	-	105	M5×6-30D-GBT	L025-GBT	3.78
GBT-SK50-CK2-135	2	24	14	26.6	6.45	75	135	M5×6-30D-GBT	L025-GBT	3.89
GBT-SK50-CK2-165	2	24	14	31.9	6.45	75	165	M5×6-30D-GBT	L025-GBT	4.08
GBT-SK50-CK3-085	1	31	18	-	7.9	-	85	M6×9-30D-GBT	L03-GBT	3.8
GBT-SK50-CK3-110	1	31	18	-	7.9	-	110	M6×9-30D-GBT	L03-GBT	3.95
GBT-SK50-CK3-140	2	31	18	32.7	7.9	85	140	M6×9-30D-GBT	L03-GBT	4.09
GBT-SK50-CK3-170	2	31	18	38	7.9	85	170	M6×9-30D-GBT	L03-GBT	4.31
GBT-SK50-CK4-100	1	39	22	-	10	-	100	M8×12-30D-GBT	L04-GBT	3.98
GBT-SK50-CK4-160	2	39	22	42.5	10	95	160	M8×12-30D-GBT	L04-GBT	4.5
GBT-SK50-CK4-205	2	39	22	50	10	95	205	M8×12-30D-GBT	L04-GBT	5.13
GBT-SK50-CK5-090	1	50	28	-	13	-	90	M10×16-30D-GBT	L05-GBT	4.3
GBT-SK50-CK5-165	1	50	28	-	13	-	165	M10×16-30D-GBT	L05-GBT	5.2
GBT-SK50-CK5-210	2	50	28	57.8	13	120	210	M10×16-30D-GBT	L05-GBT	5.92
GBT-SK50-CK5-270	2	50	28	68.4	13	120	270	M10×16-30D-GBT	L05-GBT	7.23
GBT-SK50-CK6-085	1	64	36	-	16	-	85	M12×20-30D-GBT	L06-GBT	4.28
GBT-SK50-CK6-155	1	64	36	-	16	-	155	M12×20-30D-GBT	L06-GBT	5.97
GBT-SK50-CK6-215	1	64	36	-	16	-	215	M12×20-30D-GBT	L06-GBT	7.43
GBT-SK50-CK6-250	1	64	36	-	16	-	250	M12×20-30D-GBT	L06-GBT	8.27
GBT-SK50-CK6-300	2	64	36	80.5	16	160	300	M12×20-30D-GBT	L06-GBT	10.21
GBT-SK50-CK7-085	1	90	46	-	19.15	-	85	M20×29-30D-GBT	L10-GBT	4.96
GBT-SK50-CK7-150	1	90	46	-	19.15	-	150	M20×29-30D-GBT	L10-GBT	6.52
GBT-SK50-CK7-210	1	90	46	-	19.15	-	210	M20×29-30D-GBT	L10-GBT	8.55
GBT-SK50-CK7-250	1	90	46	-	19.15	-	250	M20×29-30D-GBT	L10-GBT	10.35
GBT-SK50-CK7-300	1	90	46	-	19.15	-	300	M20×29-30D-GBT	L10-GBT	12.55
GBT-SK50-CK7-350	1	90	46	-	19.15	-	350	M20×29-30D-GBT	L10-GBT	13.25

CK接口等径延长杆

EXTENSION WITH CK ADAPTOR



CK接口缩径杆

REDUCTION WITH CK ADAPTOR

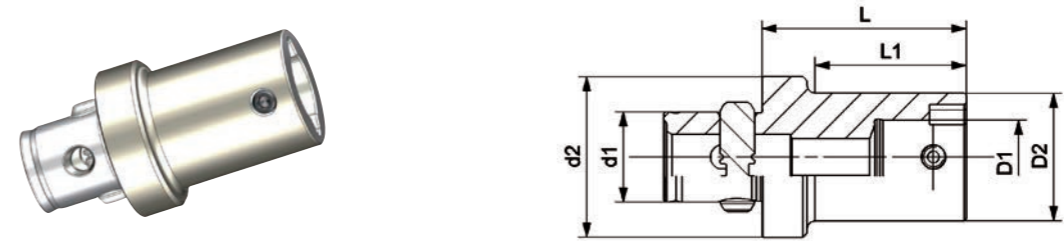

技术参数 | Technical parameters

单位 | Unit: mm

订货号 Ordering code	D	d1	d2	L	侧固螺钉 Screw (Side-fixed)	扳手 Key	重量 Weight
GBT-CK1-CK1-030	19	11	11	30	M5×5-30D-GBT	L025-GBT	0.06
GBT-CK2-CK2-030	24	14	14	30	M5×6-30D-GBT	L025-GBT	0.09
GBT-CK3-CK3-030	31	18	18	30	M6×9-30D-GBT	L03-GBT	0.14
GBT-CK4-CK4-045	39	22	22	45	M8×12-30D-GBT	L04-GBT	0.29
GBT-CK4-CK4-060	39	22	22	60	M8×12-30D-GBT	L04-GBT	0.47
GBT-CK5-CK5-060	50	28	28	60	M10×16-30D-GBT	L05-GBT	0.75
GBT-CK5-CK5-090	50	28	28	90	M10×16-30D-GBT	L05-GBT	1.18
GBT-CK6-CK6-060	64	36	36	60	M12×20-30D-GBT	L06-GBT	1.46
GBT-CK6-CK6-100	64	36	36	100	M12×20-30D-GBT	L06-GBT	2.35
GBT-CK7-CK7-105	90	46	46	105	M20×29-30D-GBT	L10-GBT	5.28

技术参数 | Technical parameters

单位 | Unit: mm

订货号 Ordering code	D1	D2	d1	d2	L1	L	侧固螺钉 Screw (Side-fixed)	扳手 Key	重量 Weight
GBT-CK2-CK1-036	11	19	14	24	30	36	M5×5-30D-GBT	L025-GBT	0.08
GBT-CK3-CK1-041	11	19	18	31	30	41	M5×5-30D-GBT	L025-GBT	0.12
GBT-CK3-CK2-037	14	24	18	31	25	37	M5×6-30D-GBT	L025-GBT	0.13
GBT-CK4-CK1-058	11	19	22	39	40	58	M5×5-30D-GBT	L025-GBT	0.24
GBT-CK4-CK2-050	14	24	22	39	36	50	M5×6-30D-GBT	L025-GBT	0.22
GBT-CK4-CK3-050	18	31	22	39	37	50	M6×9-30D-GBT	L03-GBT	0.3
GBT-CK5-CK1-060	11	19	28	50	40	60	M5×5-30D-GBT	L025-GBT	0.38
GBT-CK5-CK2-054	14	24	28	50	35	54	M5×6-30D-GBT	L025-GBT	0.38
GBT-CK5-CK2-074	14	24	28	50	55	74	M5×6-30D-GBT	L025-GBT	0.45
GBT-CK5-CK3-047	18	31	28	50	29	47	M6×9-30D-GBT	L03-GBT	0.46
GBT-CK5-CK3-072	18	31	28	50	54	72	M6×9-30D-GBT	L03-GBT	0.54
GBT-CK5-CK4-042	22	39	28	50	25	42	M8×12-30D-GBT	L04-GBT	0.43
GBT-CK5-CK4-067	22	39	28	50	50	67	M8×12-30D-GBT	L04-GBT	0.62
GBT-CK6-CK1-070	11	19	36	64	40	70	M5×5-30D-GBT	L025-GBT	0.9
GBT-CK6-CK2-063	14	24	36	64	45	63	M5×6-30D-GBT	L025-GBT	0.66

转下页 see next page →

CK接口缩径杆

REDUCTION WITH CK ADAPTOR

技术参数 | Technical parameters

单位 | Unit: mm

订货号 Ordering code	D1	D2	d1	d2	L1	L	侧固螺钉 Screw (Side-fixed)	扳手 Key	重量 Weight
GBT-CK6-CK2-093	14	24	36	64	75	93	M5×6-30D-GBT	L025-GBT	0.71
GBT-CK6-CK3-056	18	31	36	64	39	56	M6×9-30D-GBT	L03-GBT	0.7
GBT-CK6-CK3-096	18	31	36	64	79	96	M6×9-30D-GBT	L03-GBT	0.91
GBT-CK6-CK4-051	22	39	36	64	35	51	M8×12-30D-GBT	L04-GBT	0.76
GBT-CK6-CK4-101	22	39	36	64	85	101	M8×12-30D-GBT	L04-GBT	1.19
GBT-CK6-CK5-041	28	50	36	64	25	41	M10×16-30D-GBT	L05-GBT	0.72
GBT-CK6-CK5-091	28	50	36	64	75	91	M10×16-30D-GBT	L05-GBT	1.46
GBT-CK7-CK6-106	36	64	46	90	99	106	M12×20-30D-GBT	L06-GBT	3.12

芯轴基础柄 BT系列

ARBOR CONNECTION WITH BT ADAPTOR

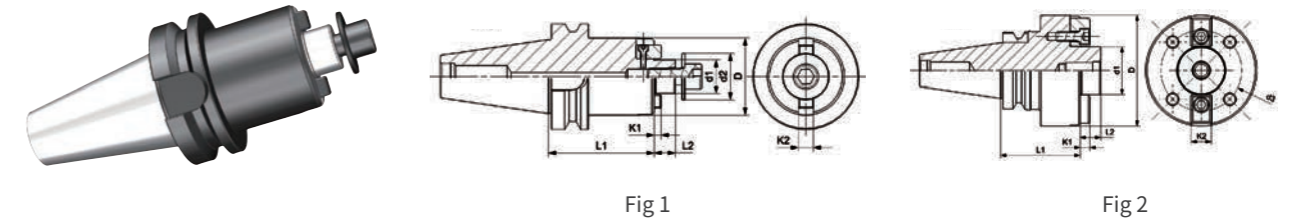

技术参数 | Technical parameters

单位 | Unit: mm

订货号 Ordering code	Fig	d1	d2	d3	D	L1	L2	K1	K2	螺栓 Screw
GBT-BT30-FMB22-045M	1	22	26	-	45	45	16.5	4.8	10	120.100.35-GBT
GBT-BT30-FMB22-060M	1	22	26	-	45	60	16.5	4.8	10	120.100.35-GBT
GBT-BT30-FMB32-060M	1	32	41	-	58	60	22	6.8	14	120.160.40-GBT
GBT-BT40-FMB22-045M	1	22	26	-	48	45	16.5	4.8	10	120.100.35-GBT
GBT-BT40-FMB22-060M	1	22	26	-	48	60	16.5	4.8	10	120.100.35-GBT
GBT-BT40-FMB22-100M	1	22	26	-	48	100	16.5	4.8	10	120.100.35-GBT
GBT-BT40-FMB22-150M	1	22	26	-	48	150	16.5	4.8	10	120.100.35-GBT
GBT-BT40-FMB32-060M	1	32	41	-	62	60	22	6.8	14	120.160.40-GBT
GBT-BT40-FMB32-100M	1	32	41	-	62	100	22	6.8	14	120.160.40-GBT
GBT-BT40-FMB32-150M	1	32	41	-	62	150	22	6.8	14	120.160.40-GBT
GBT-BT40-FMB32-200M	1	32	41	-	62	200	22	6.8	14	120.160.40-GBT
GBT-BT50-FMB22-060M	1	22	26	-	48	60	16.5	4.8	10	120.100.35-GBT
GBT-BT50-FMB22-100M	1	22	26	-	48	100	16.5	4.8	10	120.100.35-GBT
GBT-BT50-FMB22-150M	1	22	26	-	48	150	16.5	4.8	10	120.100.35-GBT
GBT-BT50-FMB22-200M	1	22	26	-	48	200	16.5	4.8	10	120.100.35-GBT

转下页 see next page →

芯轴基础柄 BT系列

ARBOR CONNECTION WITH BT ADAPTOR

芯轴基础柄 SK系列

ARBOR CONNECTION WITH SK ADAPTOR

技术参数 | Technical parameters

单位 | Unit: mm

订货号 Ordering code	Fig	d1	d2	d3	Dt	L1	L2	K1	K2	螺栓 Screw
GBT-BT50-FMB32-060M	1	32	41	-	73	60	22	6.8	14	120.160.40-GBT
GBT-BT50-FMB32-100M	1	32	41	-	73	100	22	6.8	14	120.160.40-GBT
GBT-BT50-FMB32-150M	1	32	41	-	73	150	22	6.8	14	120.160.40-GBT
GBT-BT50-FMB32-200M	1	32	41	-	73	200	22	6.8	14	120.160.40-GBT
GBT-BT50-FMC40-060M	2	40	-	66.7	98	60	25	8	16	M12X40-GBT
GBT-BT50-FMC60-075M	2	60	-	101.6	140	75	25	12.5	25.4	M16X50-GBT
GBT-BT50-FMC60-100M	2	60	-	101.6	140	100	25	12.5	25.4	M16X50-GBT

注：以上产品均可实现内冷结构。

The products above can realize internal cooling.

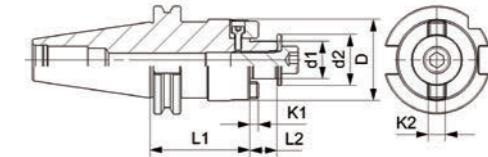

技术参数 | Technical parameters

单位 | Unit: mm

订货号 Ordering code	d1	d2	D	L1	L2	K1	K2	螺栓 Screw
GBT-SK30-FMB22-045M	22	26	45	45	16.5	4.8	10	120.100.35-GBT
GBT-SK30-FMB22-060M	22	26	45	60	16.5	4.8	10	120.100.35-GBT
GBT-SK30-FMB32-060M	32	41	58	60	22	6.8	14	120.160.40-GBT
GBT-SK40-FMB22-045M	22	26	48	45	16.5	4.8	10	120.100.35-GBT
GBT-SK40-FMB22-060M	22	26	48	60	16.5	4.8	10	120.100.35-GBT
GBT-SK40-FMB22-100M	22	26	48	100	16.5	4.8	10	120.100.35-GBT
GBT-SK40-FMB22-150M	22	26	48	150	16.5	4.8	10	120.100.35-GBT
GBT-SK40-FMB32-060M	32	41	62	60	22	6.8	14	120.160.40-GBT
GBT-SK40-FMB32-100M	32	41	62	100	22	6.8	14	120.160.40-GBT
GBT-SK40-FMB32-150M	32	41	62	150	22	6.8	14	120.160.40-GBT
GBT-SK40-FMB32-200M	32	41	62	200	22	6.8	14	120.160.40-GBT
GBT-SK50-FMB22-060M	22	26	48	60	16.5	4.8	10	120.100.35-GBT
GBT-SK50-FMB22-100M	22	26	48	100	16.5	4.8	10	120.100.35-GBT

转下页 see next page →

芯轴基础柄 SK系列

ARBOR CONNECTION WITH SK ADAPTOR

芯轴基础柄 HSK系列

ARBOR CONNECTION WITH HSK ADAPTOR

技术参数 | Technical parameters

单位 | Unit: mm

订货号 Ordering code	d1	d2	D	L1	L2	K1	K2	螺栓 Screw
GBT-SK50-FMB22-150M	22	26	48	150	16.5	4.8	10	120.100.35-GBT
GBT-SK50-FMB22-200M	22	26	48	200	16.5	4.8	10	120.100.35-GBT
GBT-SK50-FMB32-060M	32	41	73	60	22	6.8	14	120.160.40-GBT
GBT-SK50-FMB32-100M	32	41	73	100	22	6.8	14	120.160.40-GBT
GBT-SK50-FMB32-150M	32	41	73	150	22	6.8	14	120.160.40-GBT
GBT-SK50-FMB32-200M	32	41	73	200	22	6.8	14	120.160.40-GBT

注：以上产品均可实现内冷结构。

The products above can realize internal cooling.

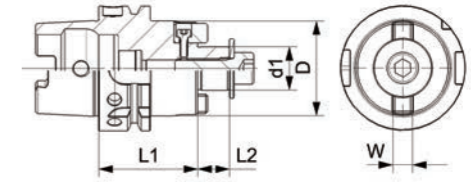

技术参数 | Technical parameters

单位 | Unit: mm

订货号 Ordering code	d1	D	L1	L2	W	螺栓 Screw
GBT-HSK40A-FMB22-050M	22	48	50	16.5	10	120.100.35-GBT
GBT-HSK50A-FMB22-060M	22	48	60	16.5	10	120.100.35-GBT
GBT-HSK63A-FMB22-050M	22	48	50	16.5	10	120.100.35-GBT
GBT-HSK63A-FMB22-100M	22	48	100	16.5	10	120.100.35-GBT
GBT-HSK63A-FMB22-160M	22	48	160	16.5	10	120.100.35-GBT
GBT-HSK63A-FMB32-060M	32	62	60	22	14	120.160.40-GBT
GBT-HSK63A-FMB32-100M	32	62	100	22	14	120.160.40-GBT
GBT-HSK63A-FMB32-160M	32	62	160	22	14	120.160.40-GBT
GBT-HSK100A-FMB22-050M	22	48	50	16.5	10	120.100.35-GBT
GBT-HSK100A-FMB22-100M	22	48	100	16.5	10	120.100.35-GBT
GBT-HSK100A-FMB32-050M	32	73	50	22	14	120.160.40-GBT
GBT-HSK100A-FMB32-100M	32	73	100	22	14	120.160.40-GBT
GBT-HSK100A-FMB32-160M	32	73	160	22	14	120.160.40-GBT

注：以上产品均可实现内冷结构。

The products above can realize internal cooling.

转接柄 TRANSFER ADAPTOR

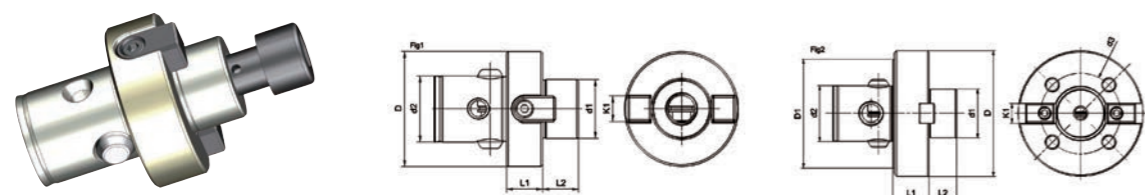

技术参数 | Technical parameters

单位 | Unit: mm

订货号 Ordering code	Fig	d1	d2	d3	D	D1	L1	L2	W	螺栓 Screw
GBT-CK4-FMB22-015M	1	22	22	-	40	-	15	16	10	120.100.35-GBT
GBT-CK6-FMB32-020M	1	32	36	-	63	-	20	20	14	120.160.40-GBT
GBT-CK7-FMC40-030M	2	40	46	66.7	104	90	30	23	16	M12X40-GBT
GBT-CK7-FMC60-046M	2	60	46	101.6	140	90	46	25	25.4	M16X50-GBT

注：以上产品均可实现内冷结构。

The products above can realize internal cooling.

刀具扩展组装示意图 EXTENDED TOOLS ASSEMBLY VIEW

